

Jābūt iespējai šim plauktam ar drēbju pakaramo stieni mainīt atrašanās vietu - paredzot stiprinājuma vietas uz augšu no norādītās vietas

Spogulis 280x550mm skapja iekšpusē uz durvju vērtnes

Priekšējais cokola panelis ar klipšiem stiprināts pie regulējamām kājām

HDF 3 mm aizmugure - iegrieztā mugura, skrūvēta

Izmantojamie materiāli:

Karkass	Lamināts E EGGER H1334 St9 Malu apdare ar 2mm ABS malu	
Aizmugure	HDF 3 mm aizmugure ar tekstūru	
Cokols	Neredzamās regulējamās kājas HAFELE H=80, Art. 637.45.308 / 637.45.906	
Vērtnes	Lamināts E EGGER H1334 St9 Malu apdare ar 2mm ABS malu	
Rokturi	HAFELE Art. 116.05.930 10/138x32mm	
Enģes	BLUM enģes ar CLIP pamatiņiem Art. 75t1550 / 173h7100	
Vērtņu aizvēršanas amortizatori	BLUM Art. 970.1002	 
Drēbju pakaramais	HAFELE ovālā caurule 30x15 Art. 342.11.0 HAFELE ovālā caurules turētājs Art. 802.07.200 HAFELE ovālā caurules gala korķis Art. 589.403.10.034	  
Spoguļa turētājs	HAFELE Art. 292.01.710	

Apģērbu skapis - ASK 1-80
800x2010x340

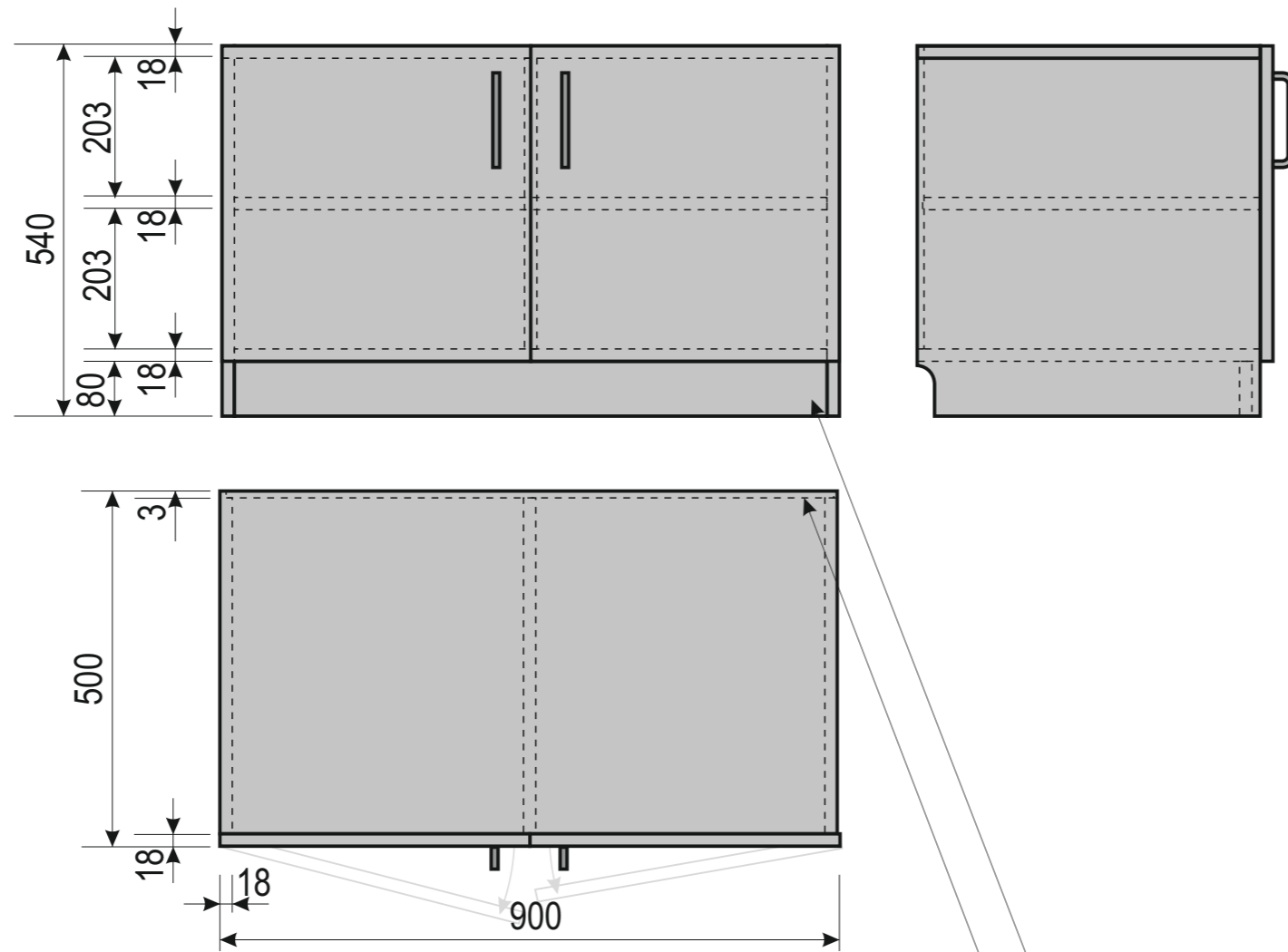

Izmantojamie materiāli:

Karkass	Lamināts E EGGER H1334 St9 Malu apdare ar 2mm ABS malu	
Aizmugure	HDF 3 mm aizmugure ar tekstūru	
Cokols	Neredzamās regulējamās kājas HAFELE H=80, Art. 637.45.308 / 637.45.906	
Vērtnes	Lamināts E EGGER H1334 St9 Malu apdare ar 2mm ABS malu	
Rokturi	HAFELE Art. 116.05.930 10/138x32mm	
Enģes	BLUM enģes ar CLIP pamatiņiem Art. 75t1550 / 173h7100	
Vērtņu aizvēršanas amortizatori	BLUM Art. 970.1002	 

Priekšējais cokola panelis ar klipšiem stiprināts pie regulējamām kājām

HDF 3 mm aizmugure - iegrieztā mugura, skrūvēta

Kancelejas skapis - KSK 1-90
900x540x500

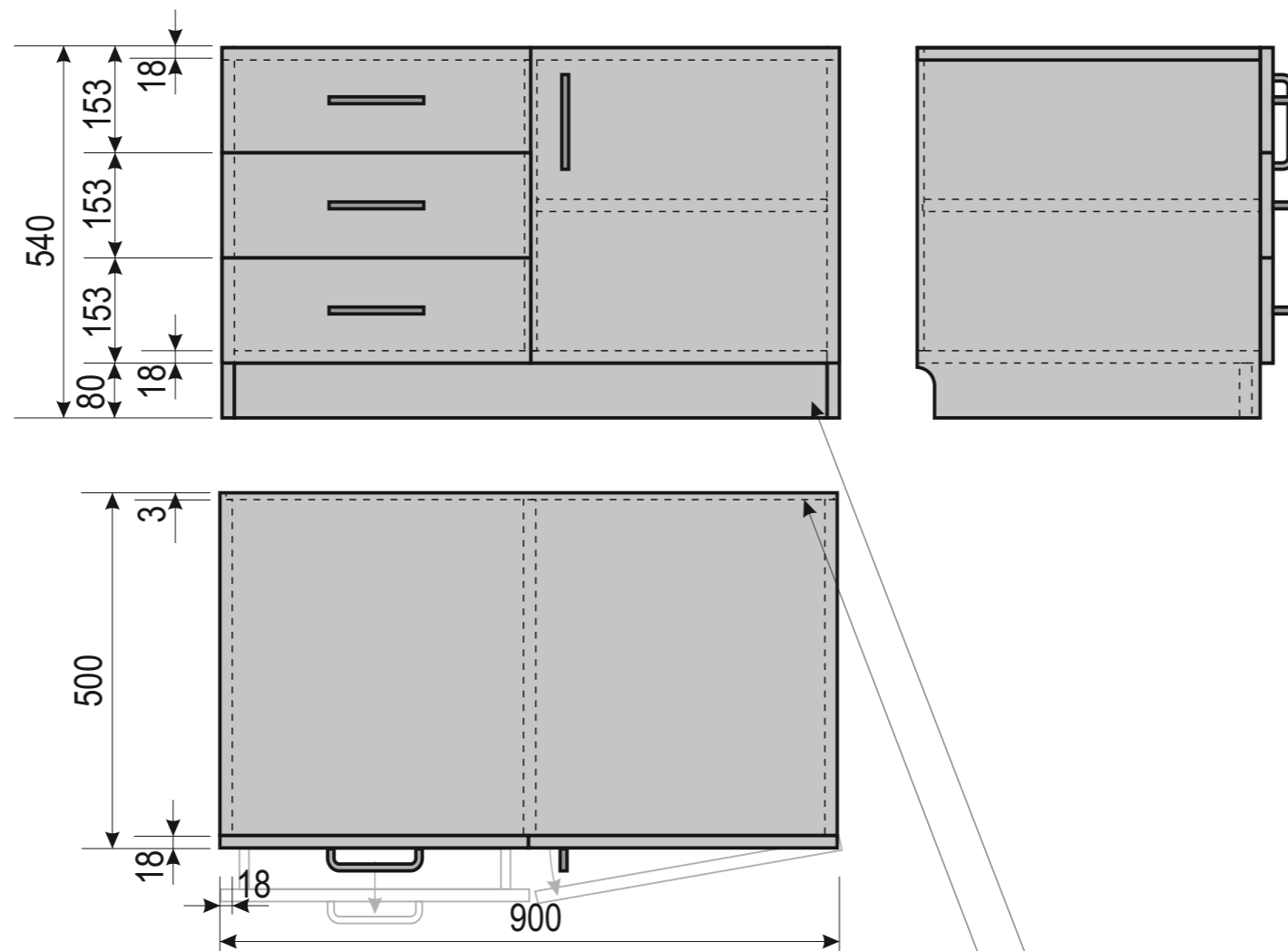

Izmantojamie materiāli:

Karkass	Lamināts E EGGER H1334 St9 Malu apdare ar 2mm ABS malu	
Aizmugure	HDF 3 mm aizmugure ar tekstūru	
Cokols	Neredzamās regulējamās kājas HAFELE H=80, Art. 637.45.308 / 637.45.906	
Vērtnes	Lamināts E EGGER H1334 St9 Malu apdare ar 2mm ABS malu	
Rokturi	HAFELE Art. 116.05.930 10/138x32mm	
Enģes	BLUM enģes ar CLIP pamatiņiem Art. 75t1550 / 173h7100	
Vērtņu aizvēršanas amortizatori	BLUM Art. 970.1002	 
Atvilktnu vadotnes	BLUM Metabox piemērojot attiecīgās atvilktnes augstumam	

Priekšējais cokola panelis ar klipšiem stiprināts pie regulējamām kājām

HDF 3 mm aizmugure - iegrieztā mugura, skrūvēta

Kancelejas skapis - KSK 2-90

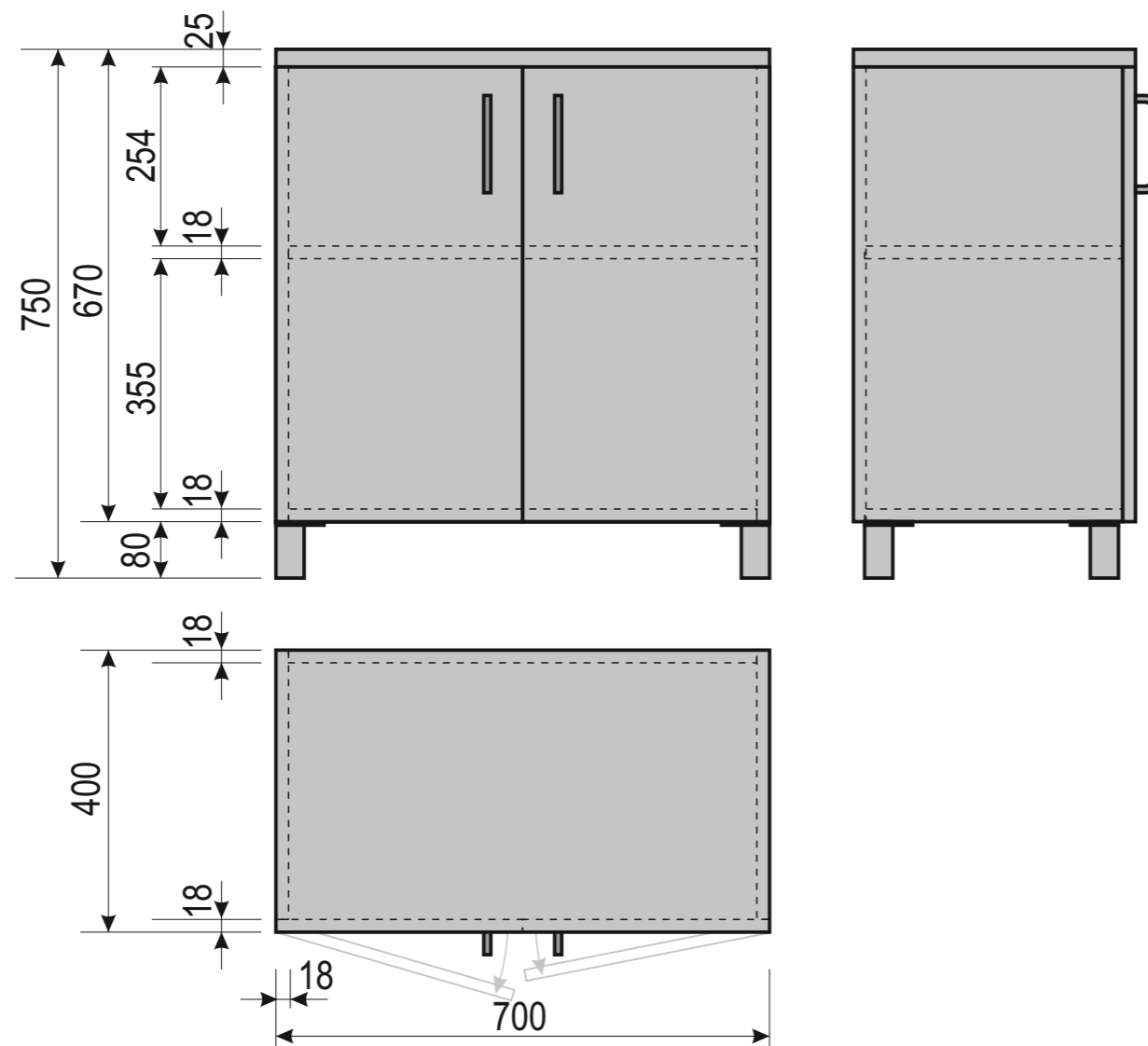

900x540x500



Izmantojamie materiāli:

Karkass	Lamināts E EGGER H1334 St9 Malu apdare ar 2mm ABS malu	
Aizmugure	Lamināts E EGGER H1334 St9	
Kājas	HAFELE Art. 634.74.461 alumīnija krāsa	
Vērtnes	Lamināts E EGGER H1334 St9 Malu apdare ar 2mm ABS malu	
Virsmā	Lamināts E EGGER H1334 St9 25mm Malu apdare ar 2mm ABS malu	
Rokturi	HAFELE Art. 116.05.930 10/138x32mm	
Enģes	BLUM enģes ar CLIP pamatiņiem Art. 75t1550 / 173h7100	
Vērtņu aizvēršanas amortizatori	BLUM Art. 970.1002	 

Papildus:

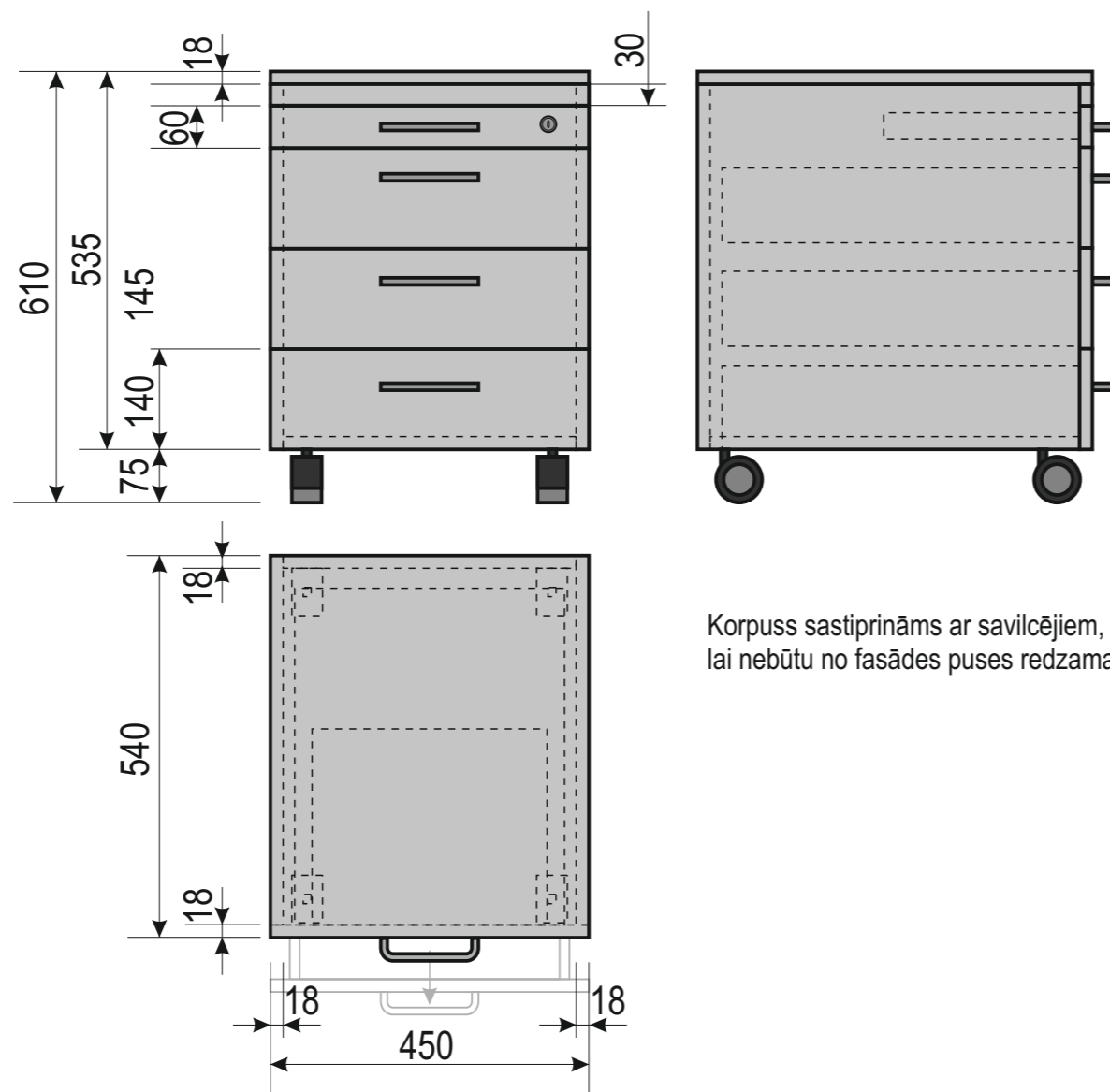

Atslēga	HAFELE 232.01.220	
Aizbīdnis	HAFELE 251.02.103/251.74.707	

Dokumentu skapis pie galda - DSKG 1-70
700x750x400



Korpuss sastiprināms ar savilcējiem,
lai nebūtu no fasādes puses redzamas skrūvju vietas!

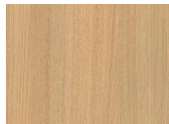

Izmantojamie materiāli:

Karkass	Lamināts E EGGER H1334 St9 Malu apdare ar 2mm ABS malu	
Aizmugure	Lamināts E EGGER H1334 St9 Malu apdare ar 2mm ABS malu	
Atvilktnu priekša	Lamināts E EGGER H1334 St9 Malu apdare ar 2mm ABS malu	
Rokturi	HAFELE Art. 116.05.930 10/138x32mm	
Atvilktnu vadotnes	BLUM Metabox <i>piemērojot attiecīgās atvilktnes augstumam</i>	
Vērtņu aizvēršanas amortizatori	BLUM Art. 970.1002	 
Atslēga	Slēdzene saslēdz visas atvilktnes ar vienu atslēgu Art. 14.01.327	
Kancelejas atvilktnē	Augšējā atvilktnē piemērojams kancelejas sadalījums HAFELE Art. 818.04.051	
Riteņi	Priekšējie divi ar bremzi TENTE Art. 00.074.642 TENTE Art. 00.074.431	 

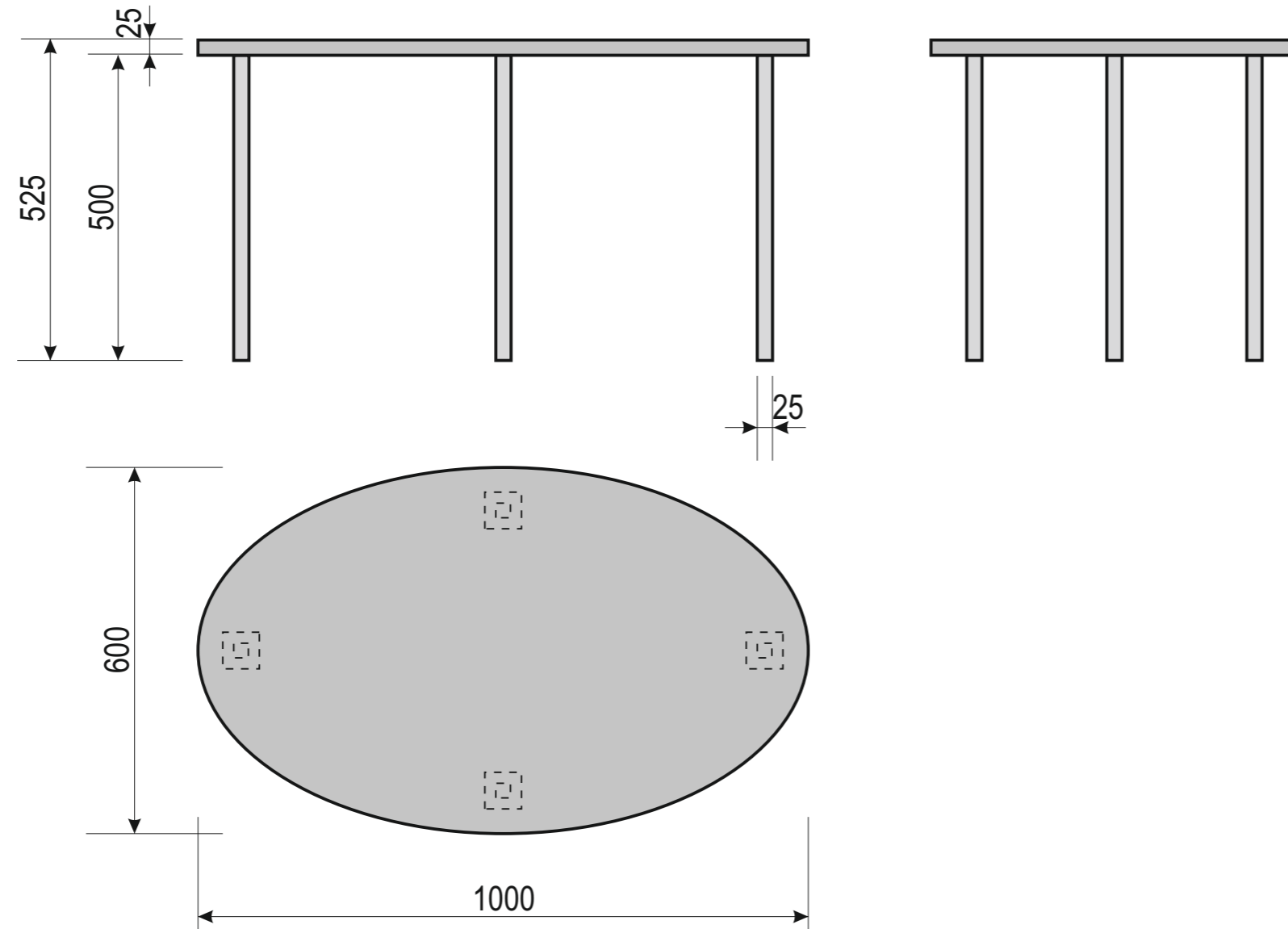
Atvilktnu bloks - AB 1-45
450x609x540



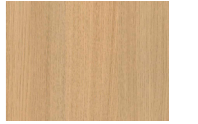

Izmantojamie materiāli:

Galda virsma	Lamināts E EGGER H1334 St9 25 mm Malu apdare ar 2mm ABS malu	
Galda kājas	HAFELE Art. 635.45.250 (hromēts)	

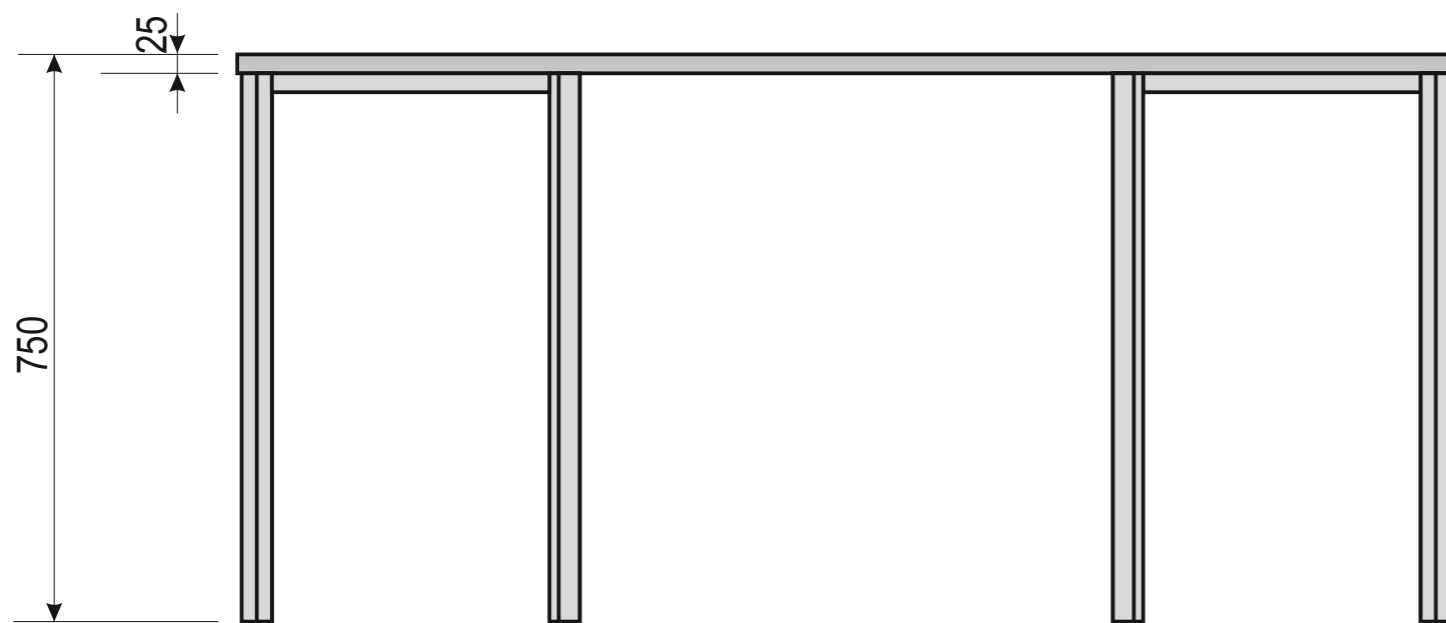
Galds zemais - G-100
1000x525x600

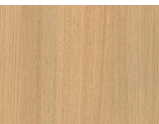

Izmantojamie materiāli:

Galda virsma	Lamināts E EGGER H1334 St9 25 mm	
	Malu apdare ar 2mm ABS malu	
Galda kājas	HAFELE Art. 633.08.225 garums 800mm RAL 9006 (alumīnija krāsa)	
Galda virsmu savienotājs	HAFELE Art. 642.42.900	

Apspriežu galds - AG-160-2 (pusaplis)
1600x750x800

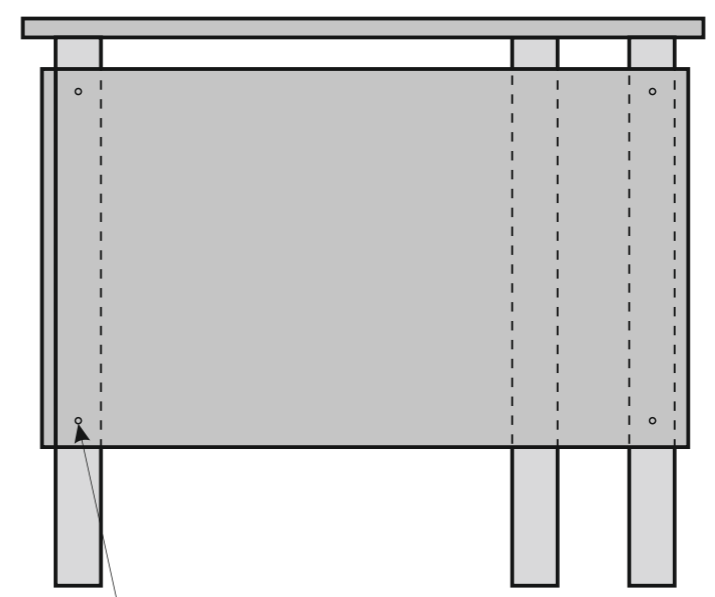
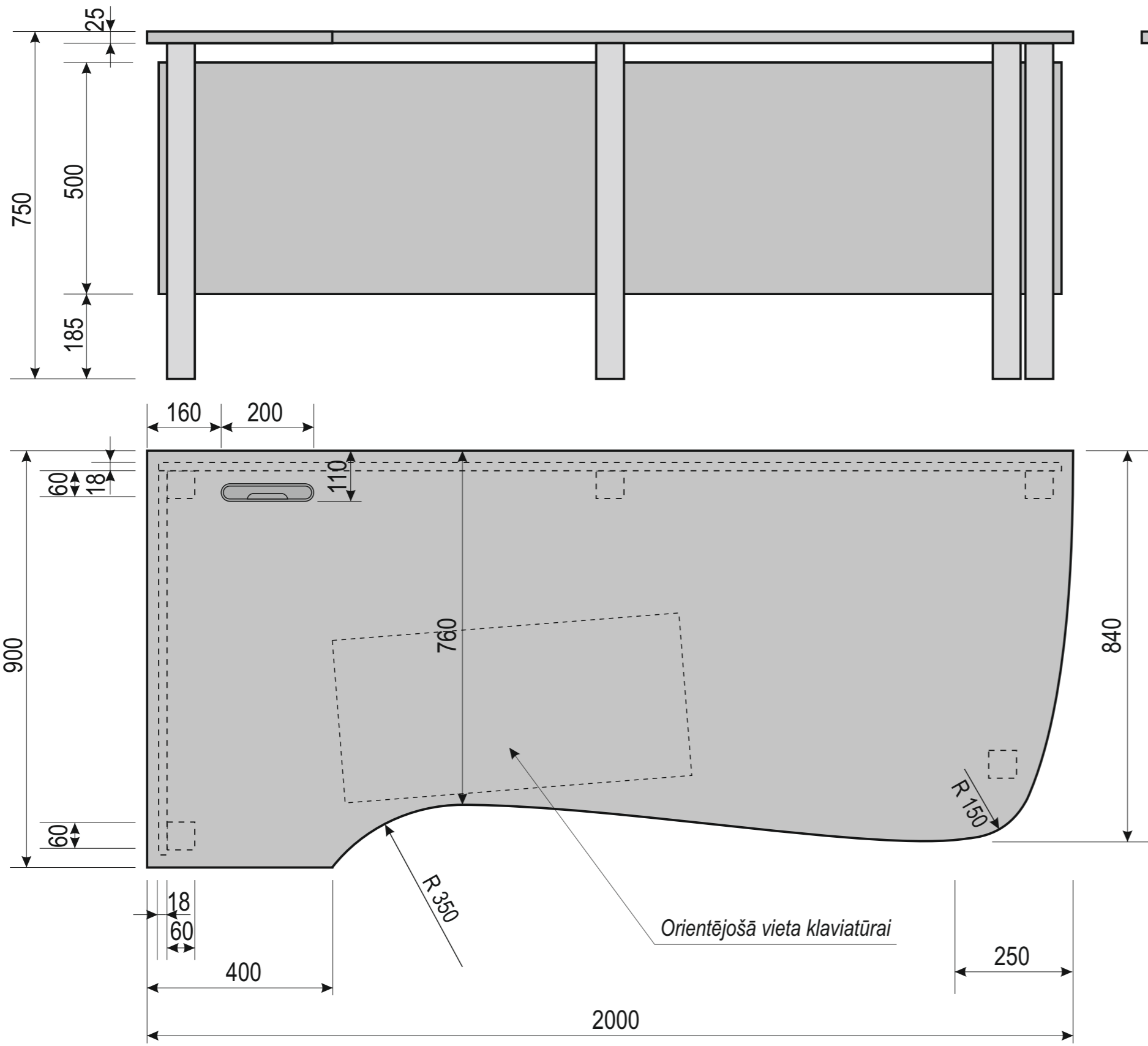

Priekšējais kāju panelis stiprināms pie galda kājām - pieskrūvējot. Skrūvju noseģšanai izmantot - noseģplāksni, tonāli saskaņotu ar paneļa materiālu.

Orientējošā vieta klaviatūrai

Rakstāmgalds - RG-1L-2
2000x750x900

RG-1L-0

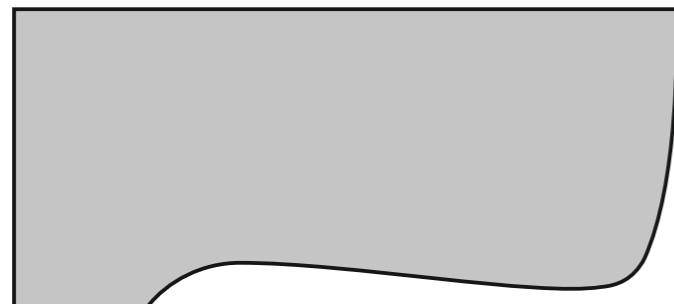

RG-1K-0

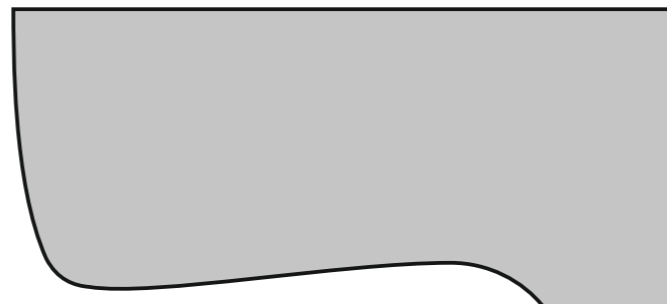

RG-1L-1

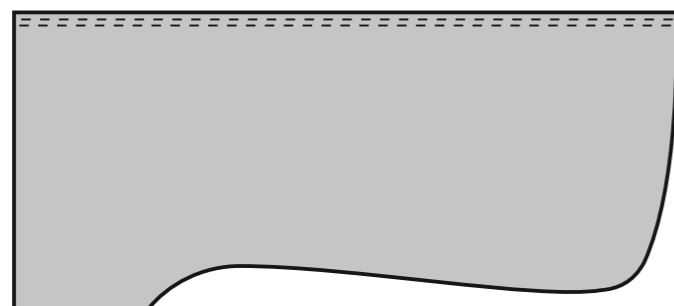

RG-1K-1

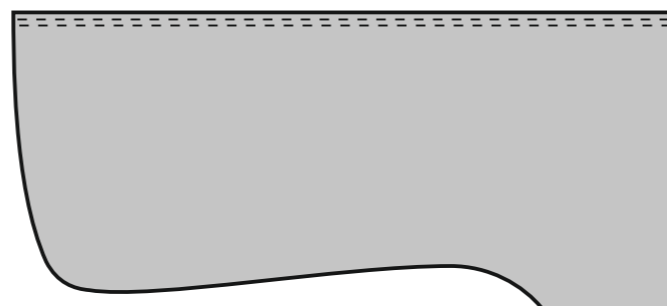



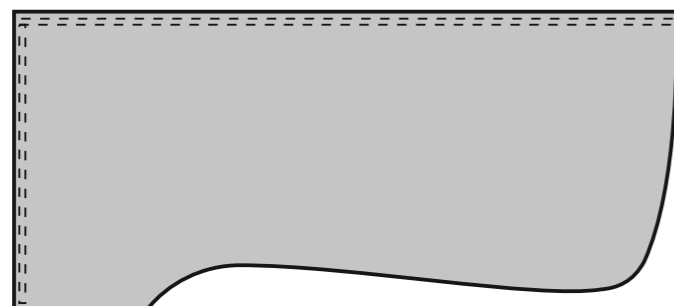

RG-1L-2

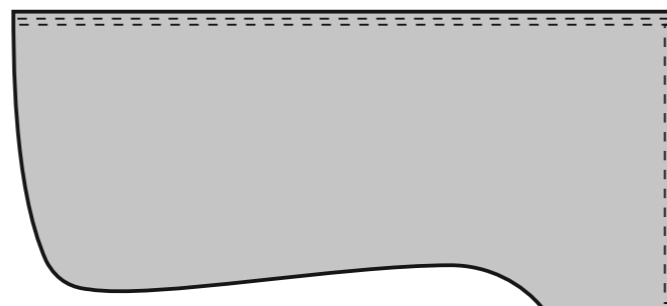

RG-1K-2

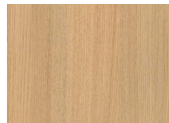

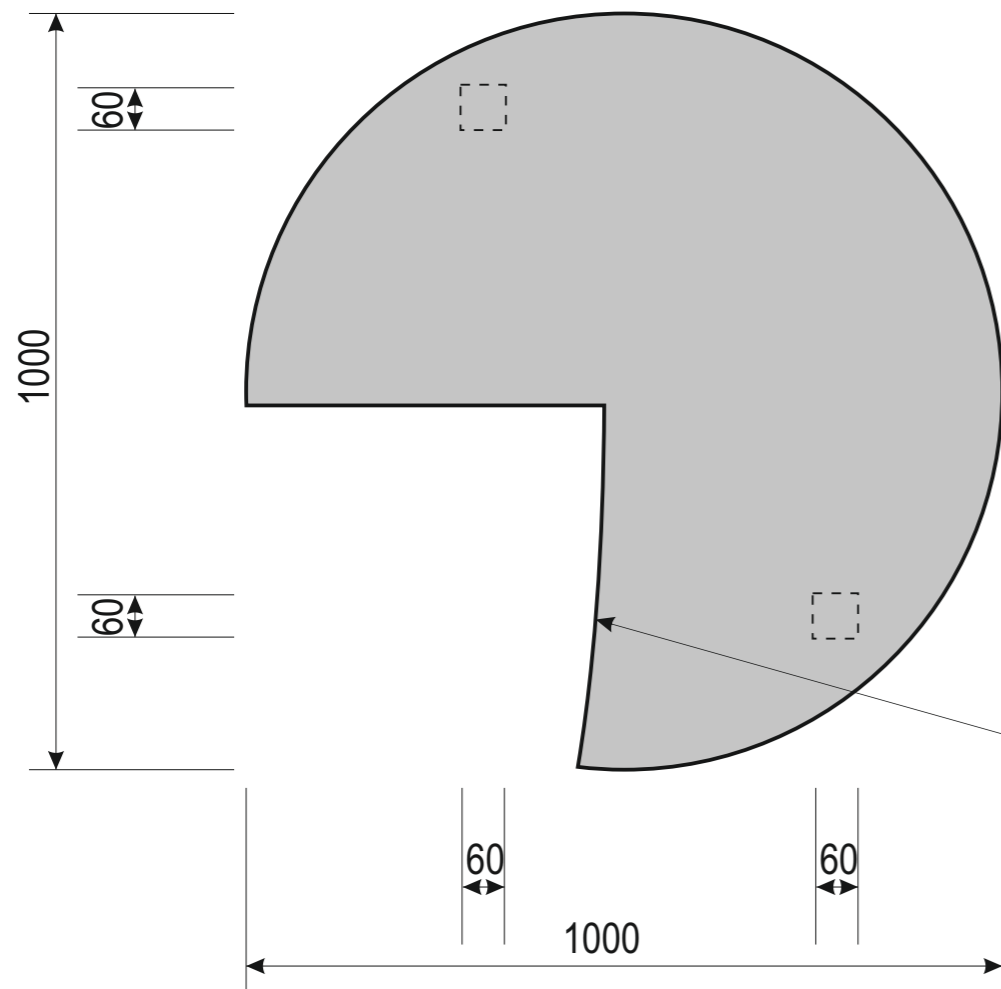
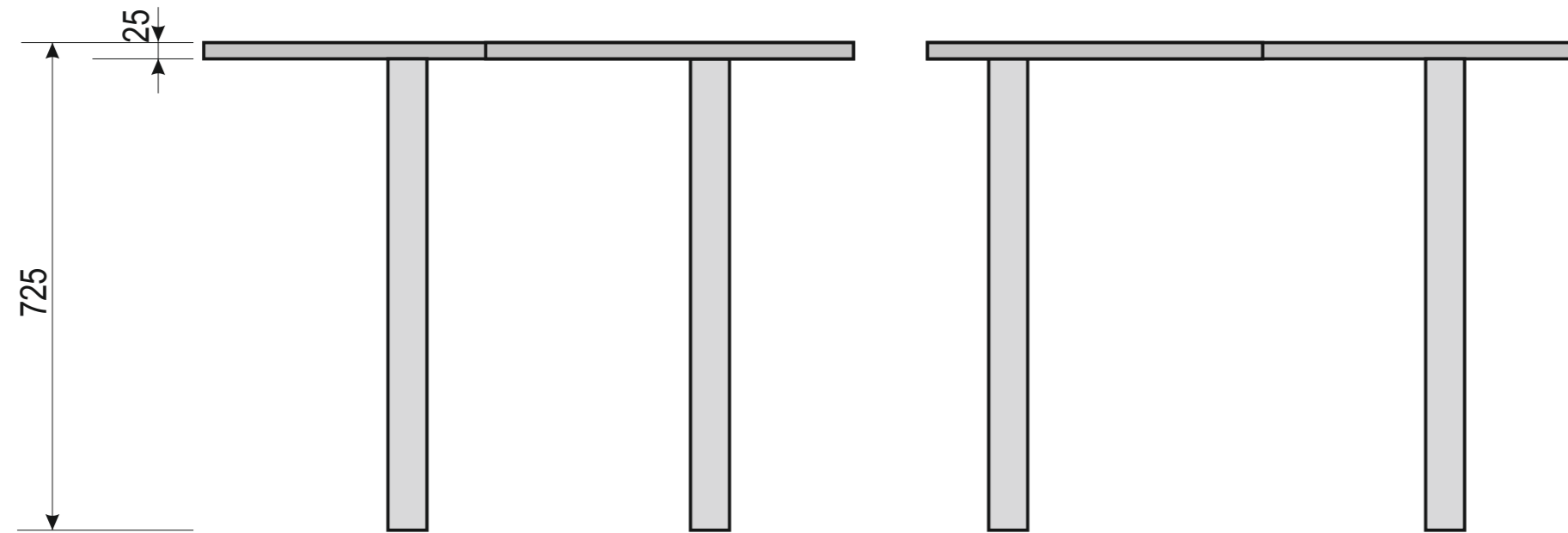

Izmantojamie materiāli:

Galda virsma	Lamināts E EGGER H1334 St9 25 mm Malu apdare ar 2mm ABS malu	
Panelis	Lamināts E EGGER H1334 St9 Malu apdare ar 2mm ABS malu	
Galda kājas	HAFELE Art. 635.59.906 alumīnija krāsa	
Pamatne klaviatūrai	HAFELE Art. 632.52.300	
Kabeļu kanāls	HAFELE Art. 631.36.200	



*Papildgalds ir par galda biezumu zemāks nekā rakstāmgalds.
Tas ir savstarpēji sastiprināts ar rakstāmgaldu.*

Izmantojamie materiāli:



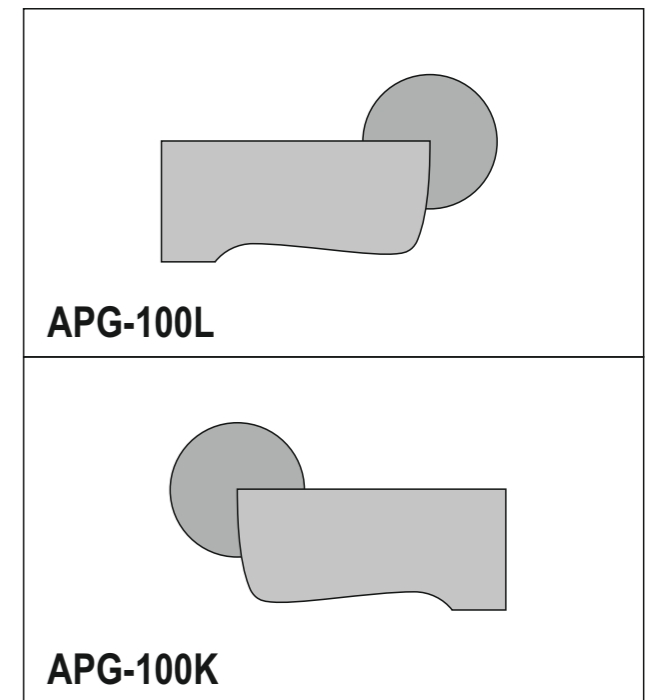

Galda virsma	Lamināts E EGGER H1334 St9 25 mm	
	Malu apdare ar 2mm ABS malu	
Panelis	Lamināts E EGGER H1334 St9	
	Malu apdare ar 2mm ABS malu	
Galda kājas	HAFELE Art. 635.59.906 alumīnija krāsa	

Apmeklētāju galda novietošanas variants

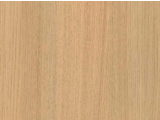
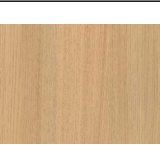

Apmeklētāju galds - APG-100L
1000x725x1000

Izmantojamie materiāli:

Galda virsma	Lamināts E EGGER H1334 St9 25 mm	
	Malu apdare ar 2mm ABS malu	
Panelis	Lamināts E EGGER H1334 St9	
	Malu apdare ar 2mm ABS malu	
Galda kājas	HAFELE Art. 635.59.906 alumīnija krāsa	
Galda virsmu savienotājs	Art. 24.03.091	

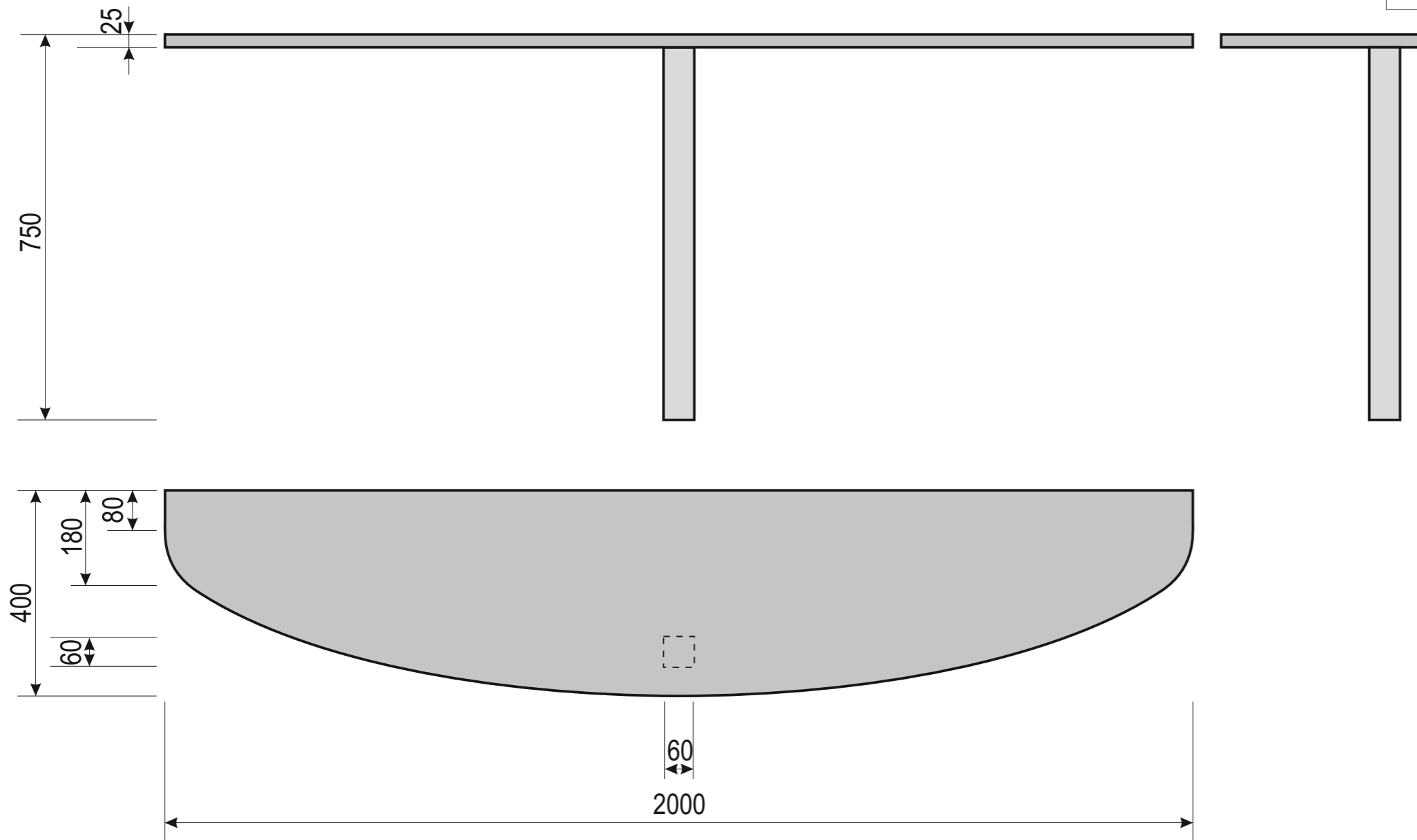

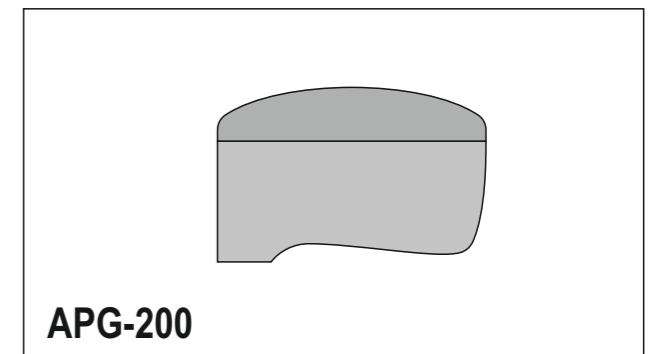

Apmeklētāju galda novietošanas variants

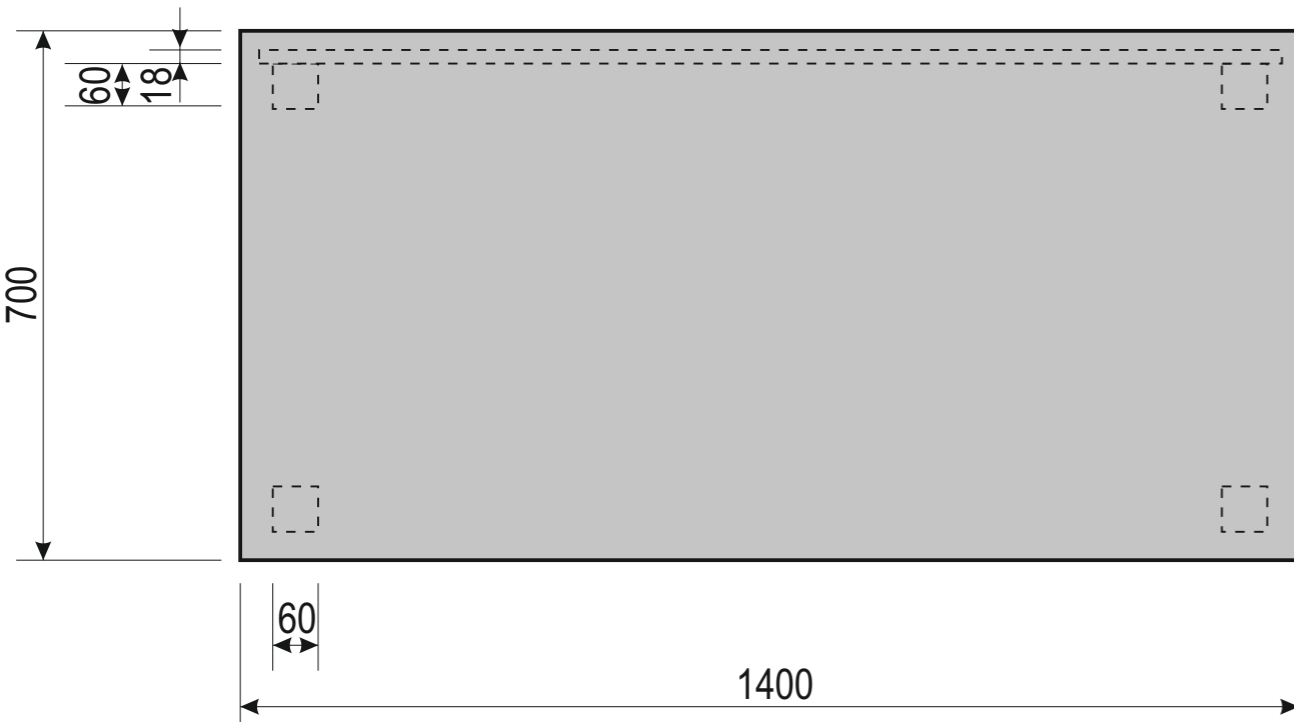
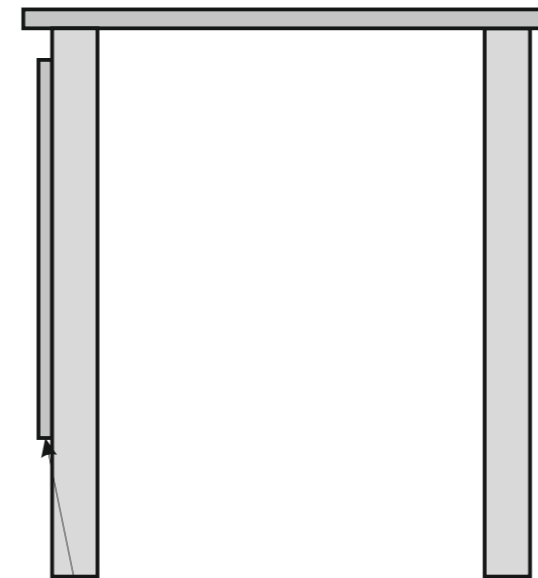
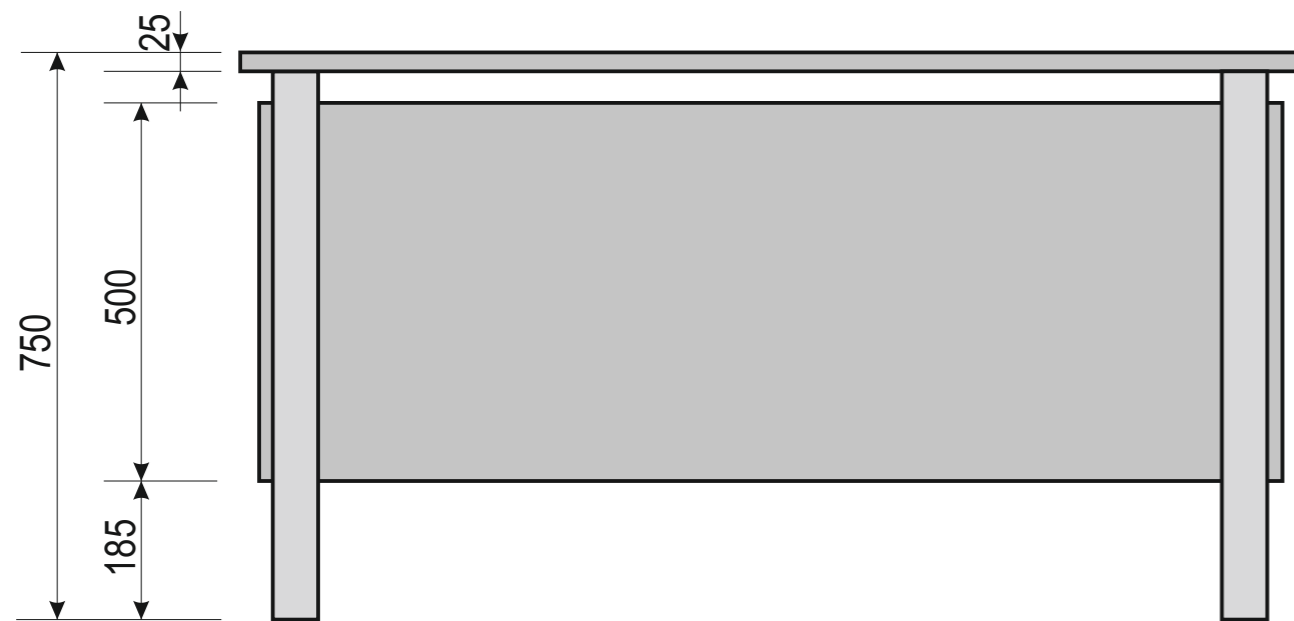

Apmeklētāju galds - APG-200
2000x750x400

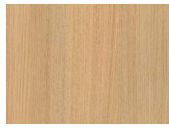

Izmantojamie materiāli:

Galda virsma	Lamināts E EGGER H1334 St9 25 mm	
	Malu apdare ar 2mm ABS malu	
Panelis	Lamināts E EGGER H1334 St9	
	Malu apdare ar 2mm ABS malu	
Galda kājas	HAFELE Art. 635.59.906 alumīnija krāsa	

*Priekšējais kāju panelis stiprināms pie galda kājām - pieskrūvējot.
Skrūvju noseģšanai izmantot - noseģplāksni, tonāli saskaņotu
ar paneļa materiālu.*

Rakstāmgalds - RG-3-1

1400x750x700

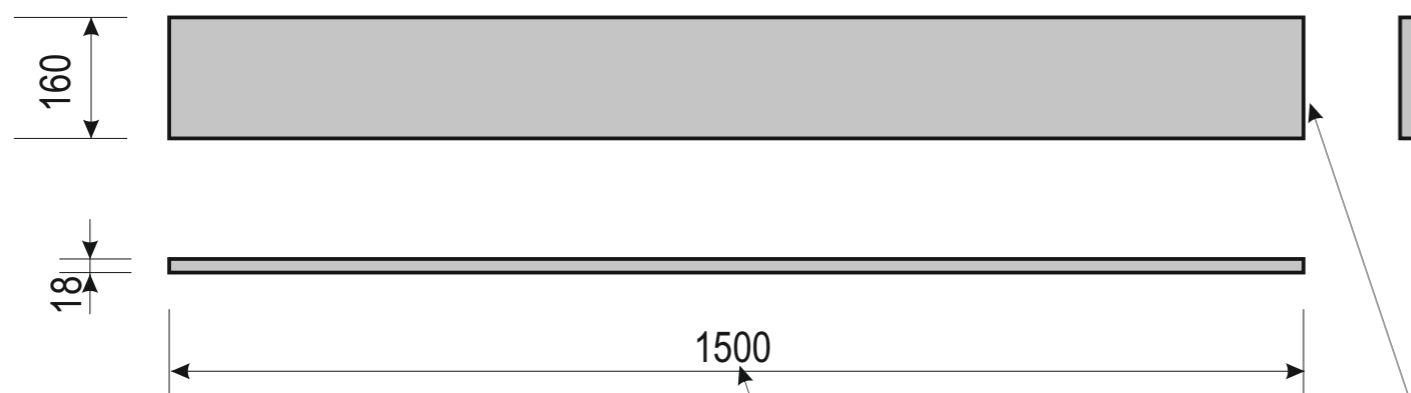

Izmantojamie materiāli:

Panelis	Lamināts E EGGER H1334 St9 25 mm	
	Malu apdare ar 2mm ABS malu	

*Paneļa stiprinājums pie sienas - ideālā variantā - neredzams no fasādes puses, bet ja sienas reljefs to nepieļauj, tad - pieskrūvējot.
Skrūvju noseģšanai izmantot - noseģplāksni, tonāli saskaņotu ar paneļa materiālu.*

Sienas paneļa garums var tikt mainīts, pieskaņojot to konkrētai situācijai telpā

Sienas panelis - SP-1
1500x160x18

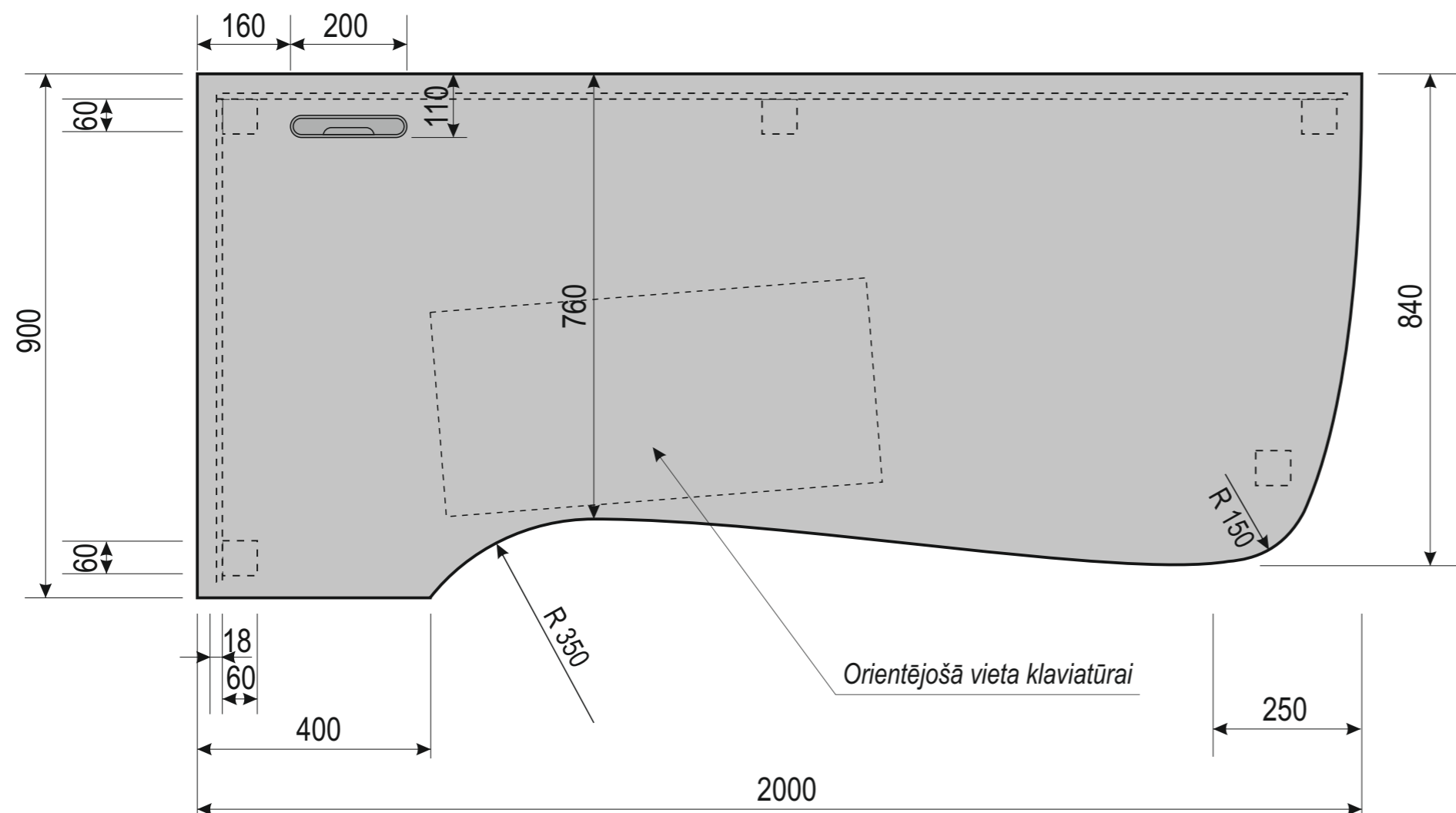
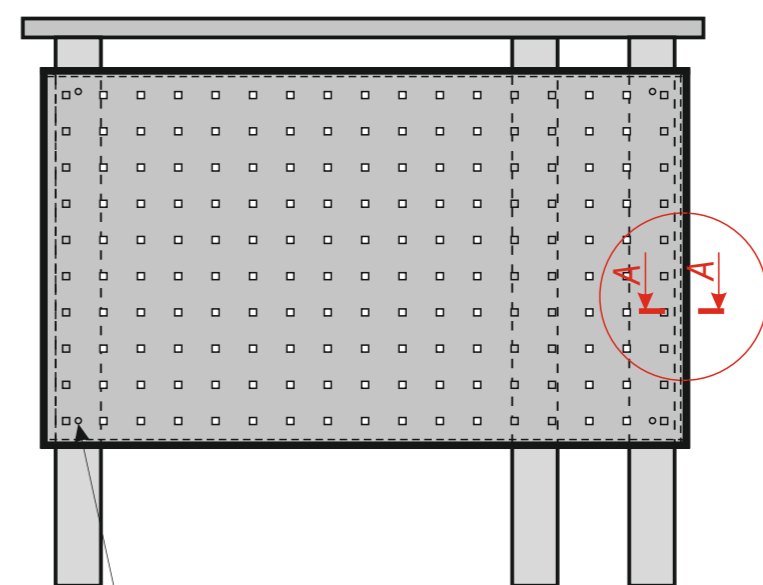
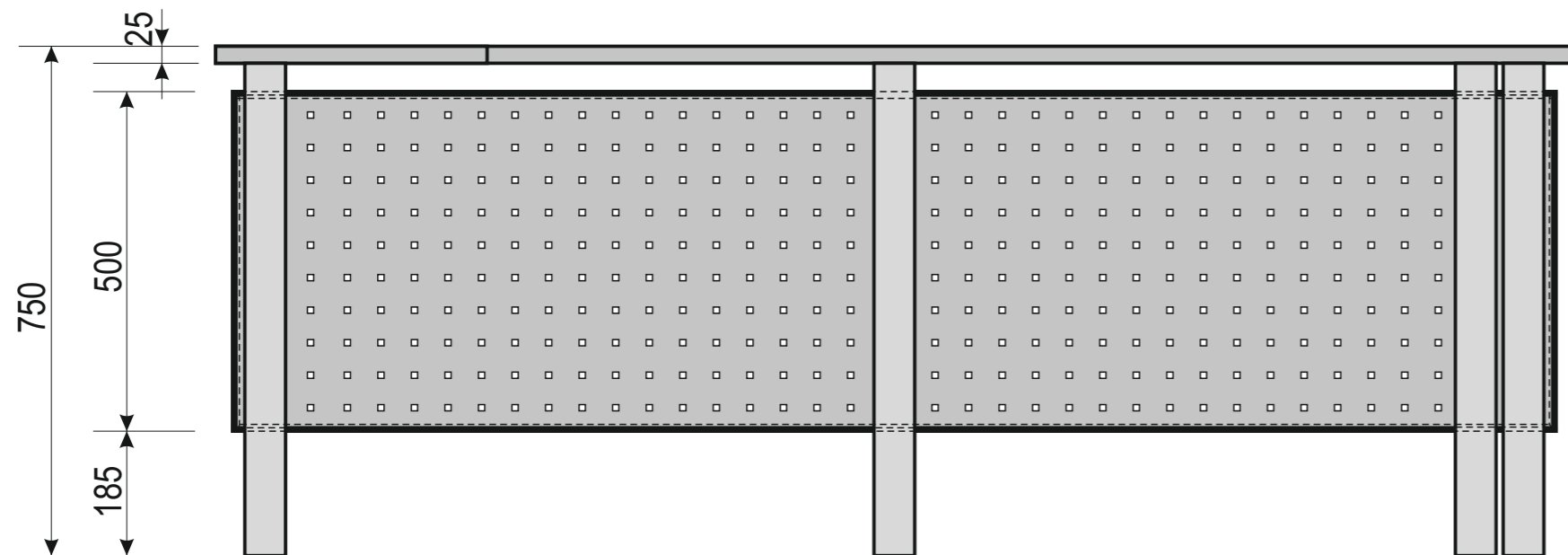

Priekšējais kāju panelis stiprināms pie galda kājām - pieskrūvējot. Skrūvju noseģšanai izmantot - noseģplāksni, tonāli saskaņotu ar paneļa materiālu.

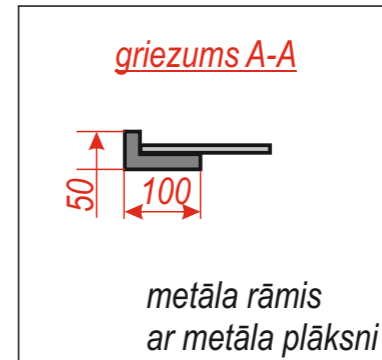

Rakstāmgalds - RG-4L-2
2000x750x900

RG-4L-0

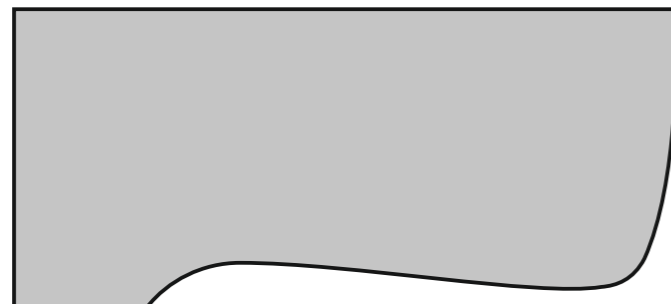

RG-4K-0

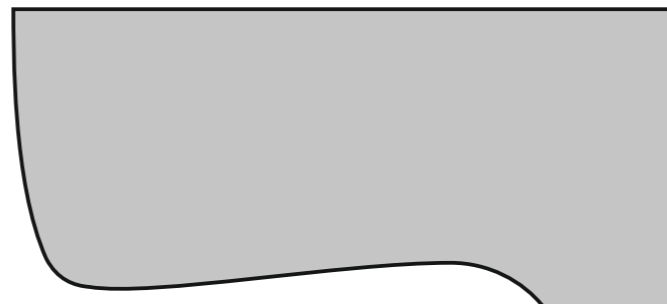

RG-4L-1

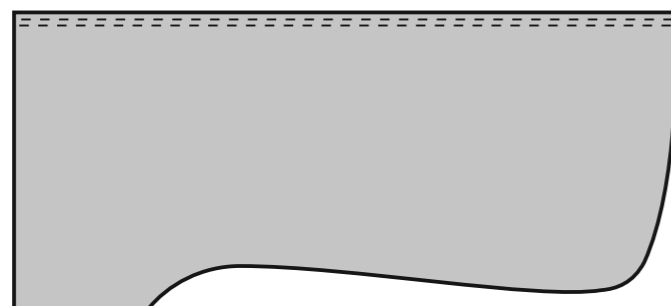

RG-4K-1

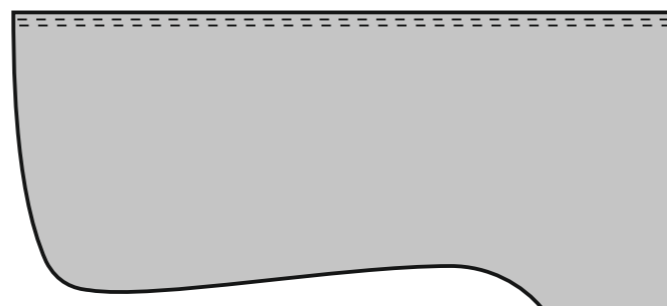

RG-4L-2

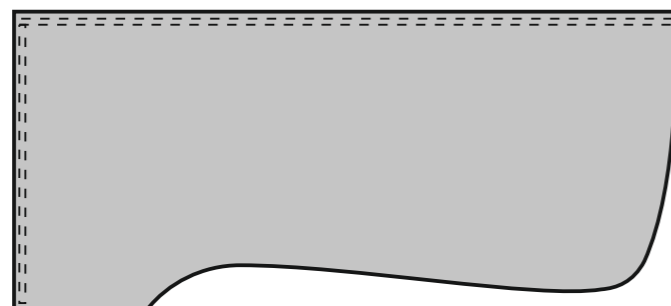

RG-4K-2

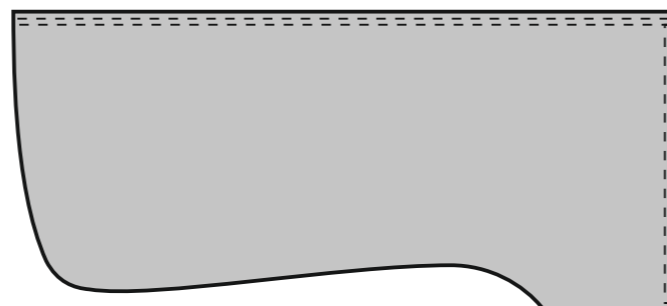

Izmantojamie materiāli:

Galda virsma	Lamināts E EGGER H3031 St9 25 mm <i>Dark Cordoba Olive</i> Malu apdare ar 2mm ABS malu	
Panelis	Perforēta loksne - melna; Qg 10-30; 1,0*1000*2000 mm kods 300203 www.metaluveikals.lv Tonis RAL 9006	
L veida metāla rāmis panelim	Tonis RAL 9006	
Galda kājas	HAFELE Art. 635.59.906 alumīnija krāsa	
Pamatne klaviatūrai	HAFELE Art. 632.52.300	
Kabeļu kanāls	HAFELE Art. 631.36.200	

Rakstāmgalds RG-4 specifikācija

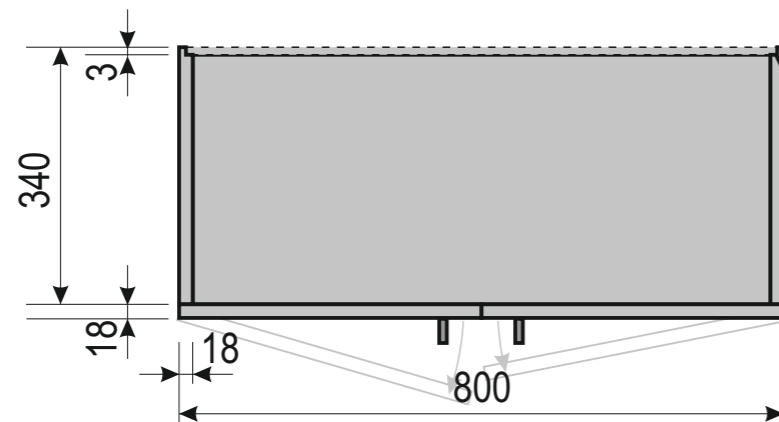
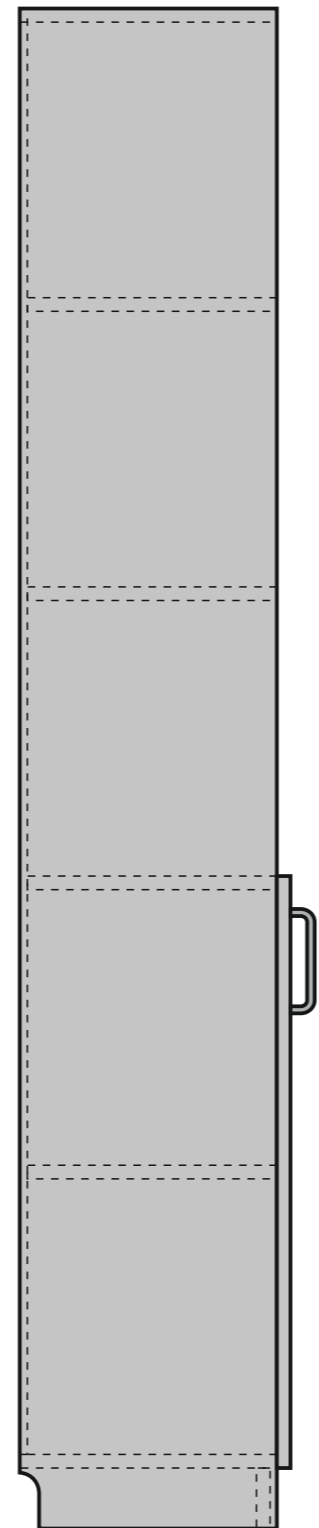
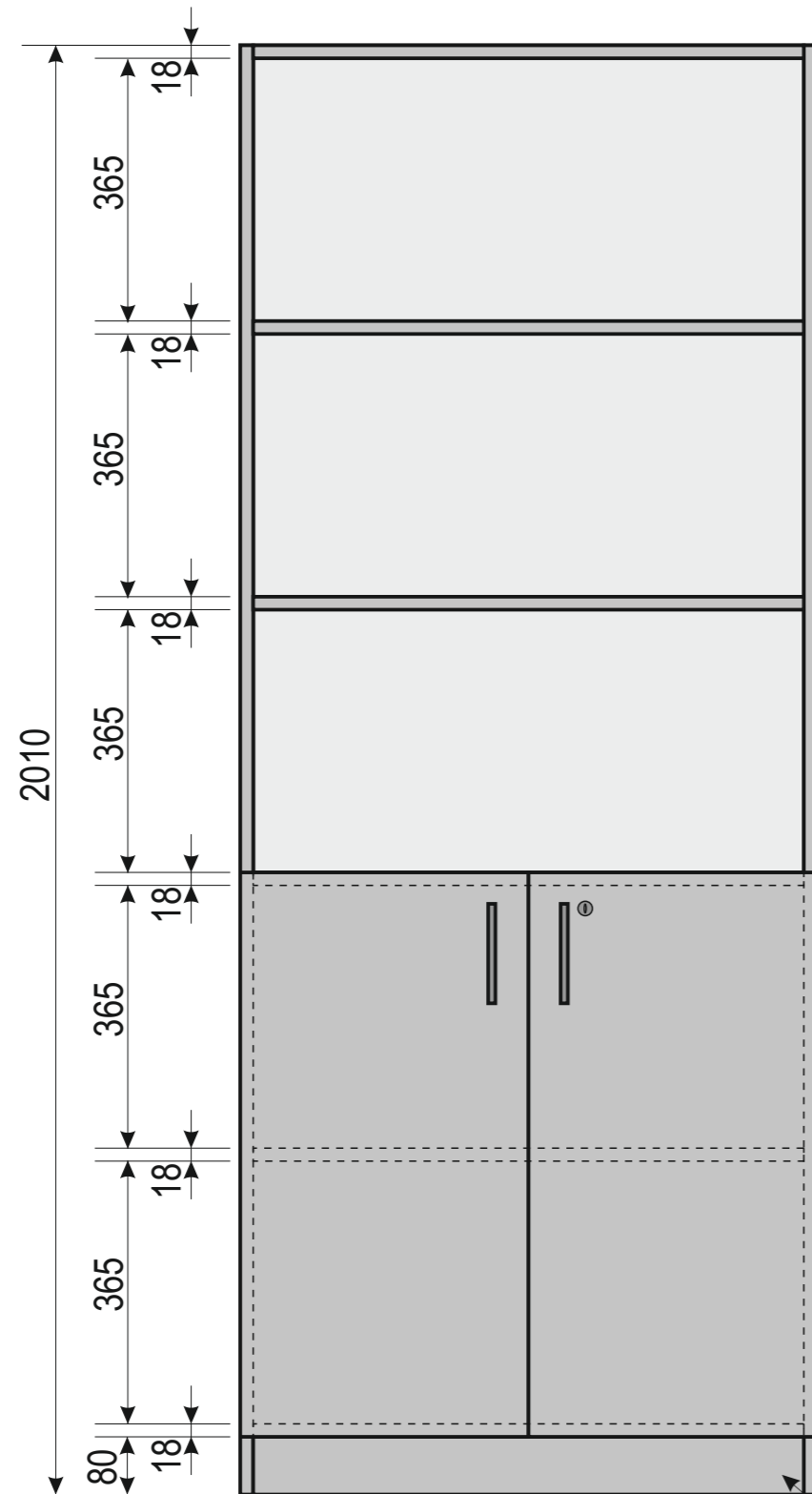



Priekšējais cokola panelis ar klipšiem stiprināts pie regulējamām kājām

HDF 3 mm aizmugure - iegrieztā mugura, skrūvēta

Izmantojamie materiāli:

Karkass	Lamināts E EGGER H1334 St9 Malu apdare ar 2mm ABS malu	
Aizmugure	HDF 3 mm aizmugure ar tekstūru	
Cokols	Neredzamās regulējamās kājas HAFELE H=80, Art. 637.45.308 / 637.45.906	
Vērtnes	Lamināts E EGGER H1334 St9 Malu apdare ar 2mm ABS malu	
Rokturi	HAFELE Art. 116.05.930 10/138x32mm	
Enģes	BLUM enģes ar CLIP pamatiņiem Art. 75t1550 / 173h7100	
Vērtņu aizvēršanas amortizatori	BLUM Art. 970.1002	 

Papildus:

Slēdzene	HAFELE 232.01.220	
Aizbīdnis	HAFELE 251.02.103/251.74.707	 

Dokumentu skapis - DSK 2-80
800x2010x340

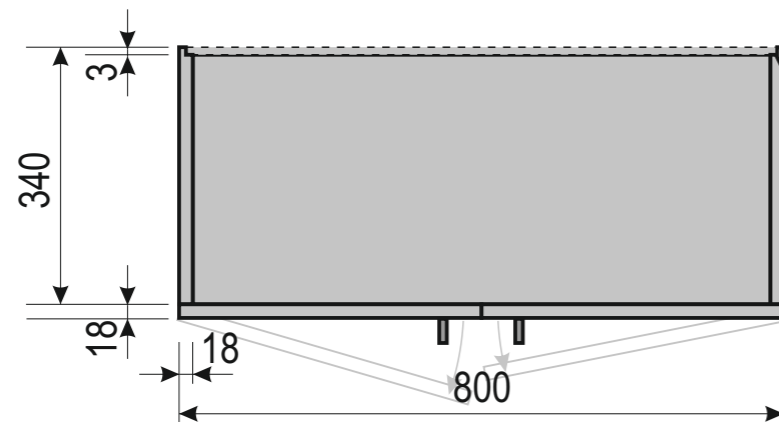
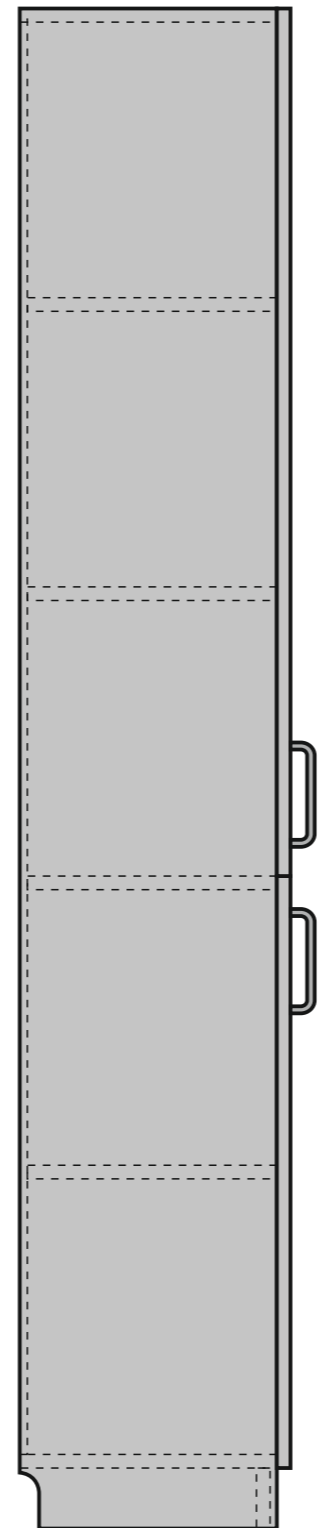
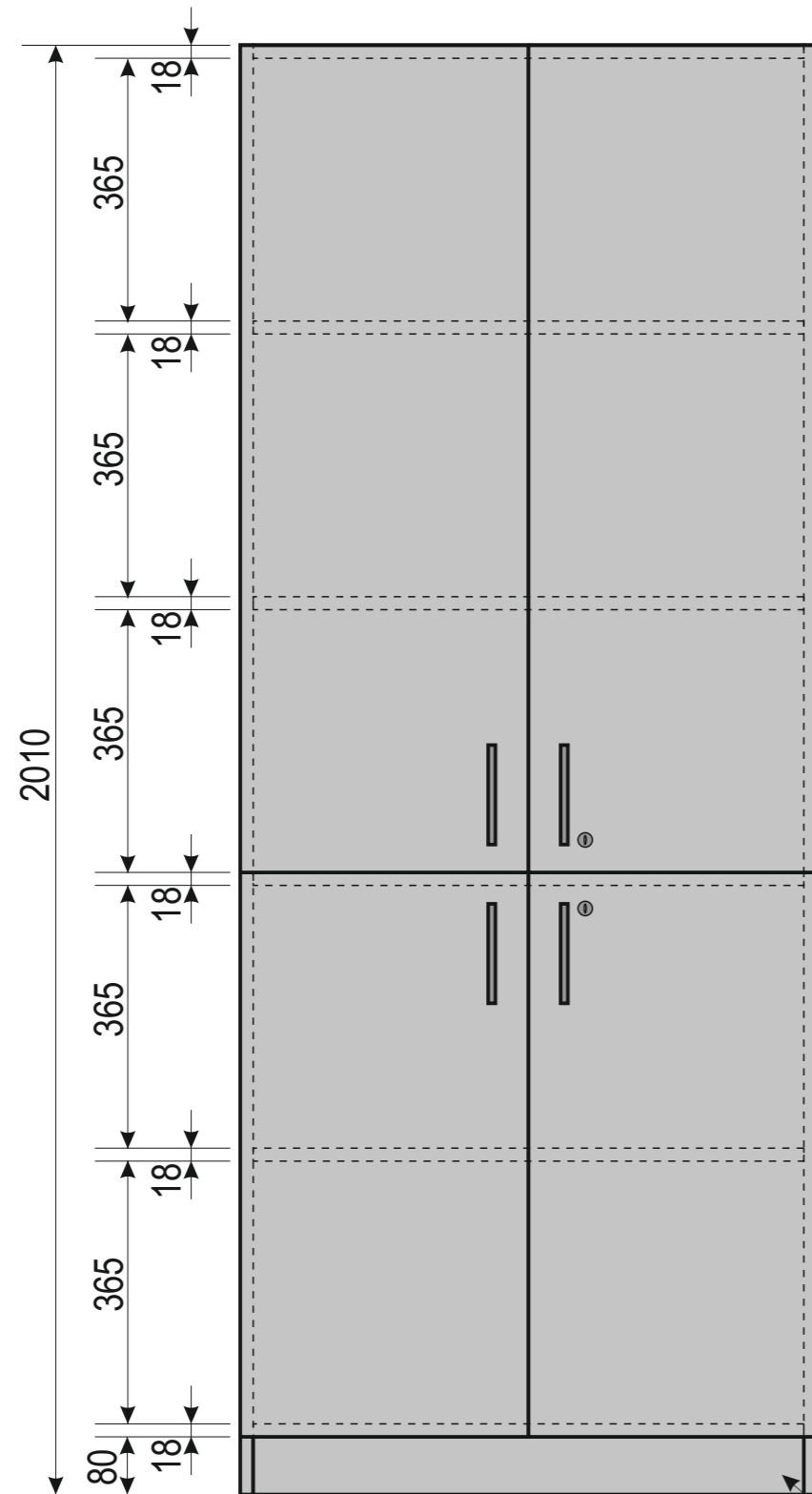



Priekšējais cokola panelis ar klipšiem stiprināts pie regulējamām kājām

HDF 3 mm aizmugure - iegrieztā mugura, skrūvēta

Izmantojamie materiāli:

Karkass	Lamināts E EGGER H1334 St9 Malu apdare ar 2mm ABS malu	
Aizmugure	HDF 3 mm aizmugure ar tekstūru	
Cokols	Neredzamās regulējamās kājas HAFELE H=80, Art. 637.45.308 / 637.45.906	
Vērtnes	Lamināts E EGGER H1334 St9 Malu apdare ar 2mm ABS malu	
Rokturi	HAFELE Art. 116.05.930 10/138x32mm	
Enģes	BLUM enģes ar CLIP pamatiņiem Art. 75t1550 / 173h7100	
Vērtņu aizvēršanas amortizatori	BLUM Art. 970.1002	 

Papildus:

Slēdzene	HAFELE 232.01.220	
Aizbīdnis	HAFELE 251.02.103/251.74.707	

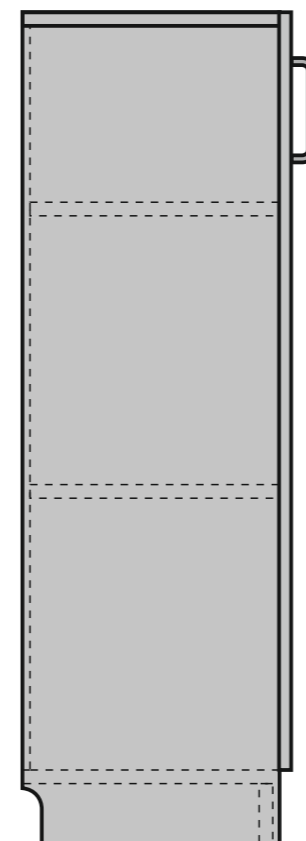
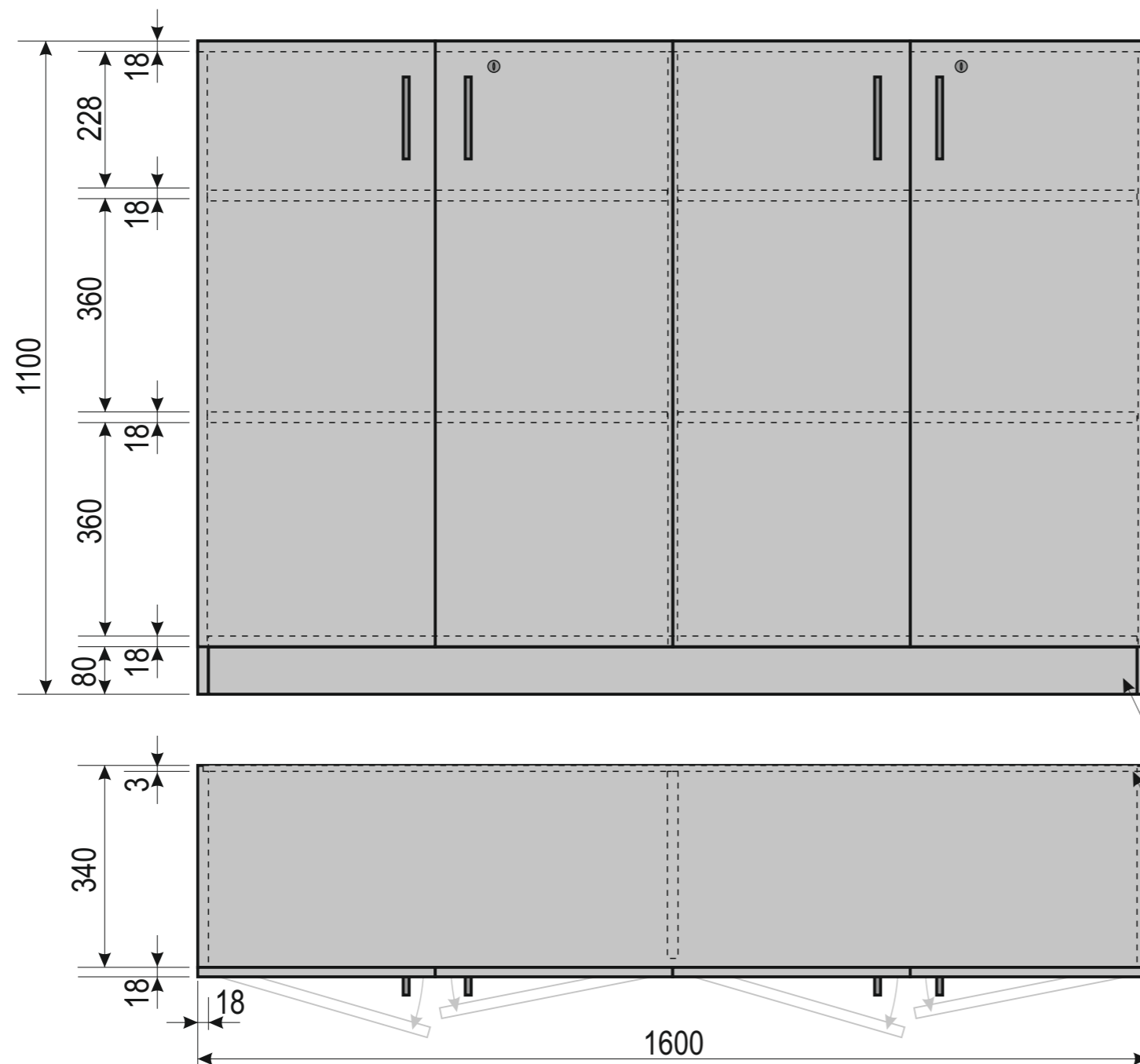

Dokumentu skapis - DSK 3-80
800x2010x340



Izmantojamie materiāli:

Karkass	Lamināts E EGGER H1334 St9 Malu apdare ar 2mm ABS malu	
Aizmugure	HDF 3 mm aizmugure ar tekstūru	
Cokols	Neredzamās regulējamās kājas HAFELE H=80, Art. 637.45.308 / 637.45.906	
Vērtnes	Lamināts E EGGER H1334 St9 Malu apdare ar 2mm ABS malu	
Rokturi	HAFELE Art. 116.05.930 10/138x32mm	
Enģes	BLUM enģes ar CLIP pamatiņiem Art. 75t1550 / 173h7100	
Vērtņu aizvēršanas amortizatori	BLUM Art. 970.1002	 

Papildus:

Slēdzene	HAFELE 232.01.220	
Aizbīdnis	HAFELE 251.02.103/251.74.707	

Priekšējais cokola panelis ar klipšiem stiprināts pie regulējamām kājām

HDF 3 mm aizmugure - iegrieztā mugura, skrūvēta

Dokumentu skapis - DSK 8-160
1600x1100x340

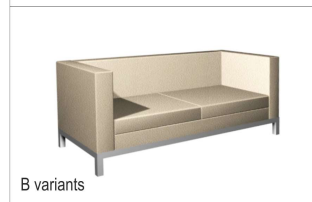
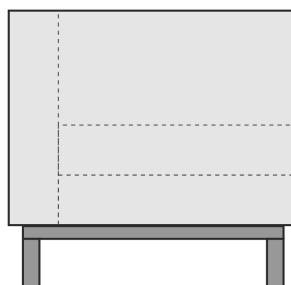
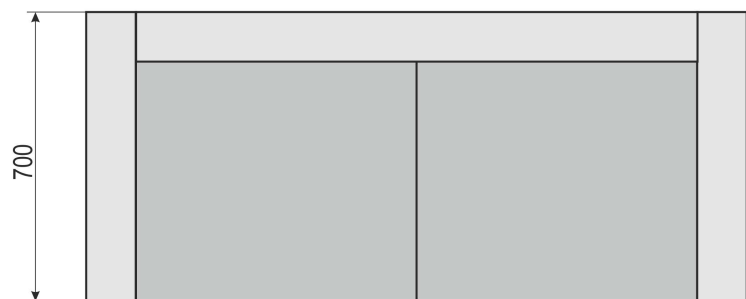
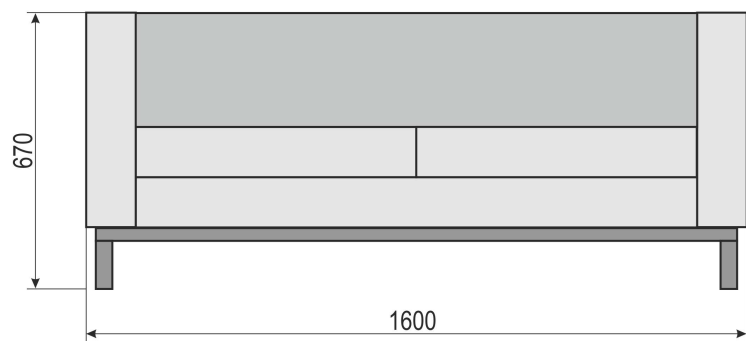

Divāna materiāls	Mākslīgā āda: A variants - melna B variants - gaiši bēša
Divāna kājas	AL vai nerūs.tērauda kājas uz rāmja

Divāns 2 vietīgs - D-2
1600x670x700

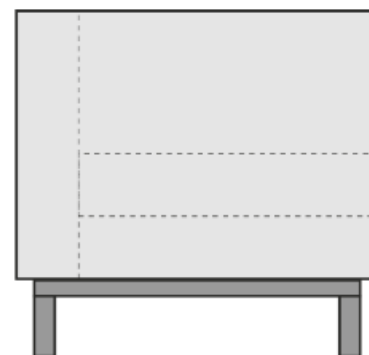
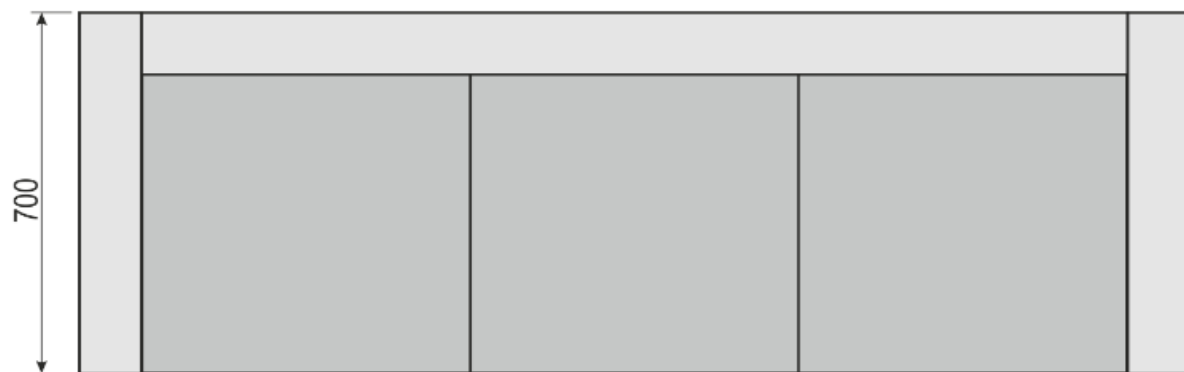
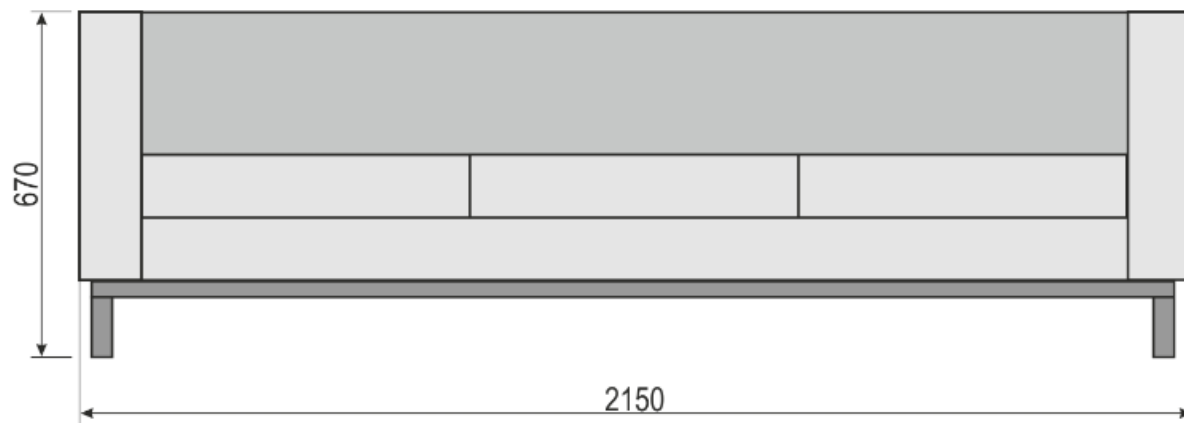

Dīvāna materiāls	Mākslīgā āda: A variants - melna B variants - gaiši bēša
Dīvāna kājas	AL vai nerūs.tērauda kājas uz rāmja

Dīvāns 3 vietīgs - D-3
2150x670x700

ŽURNĀLGALDS - VIRSSKATS

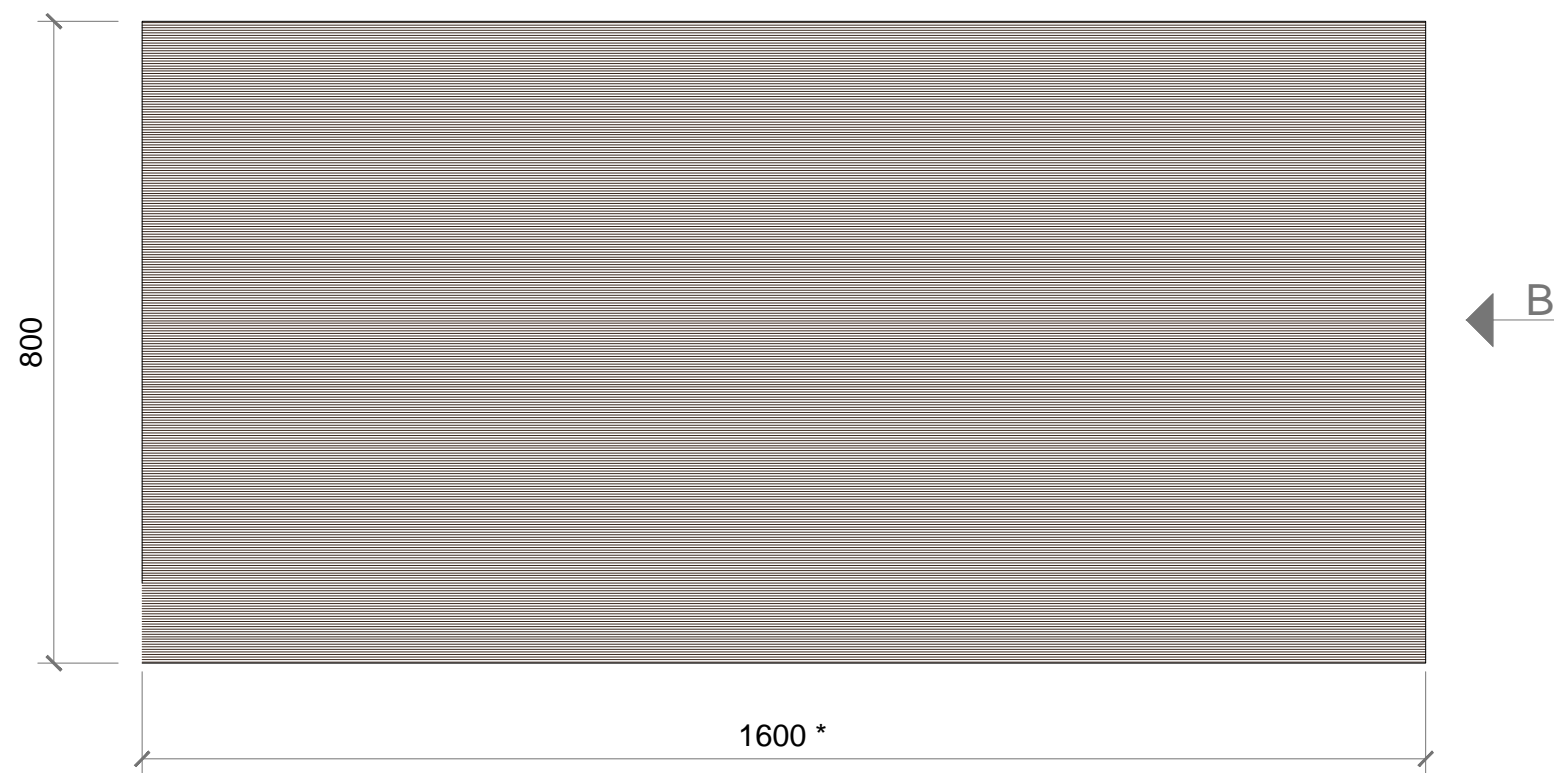

PRETSKATS (A)

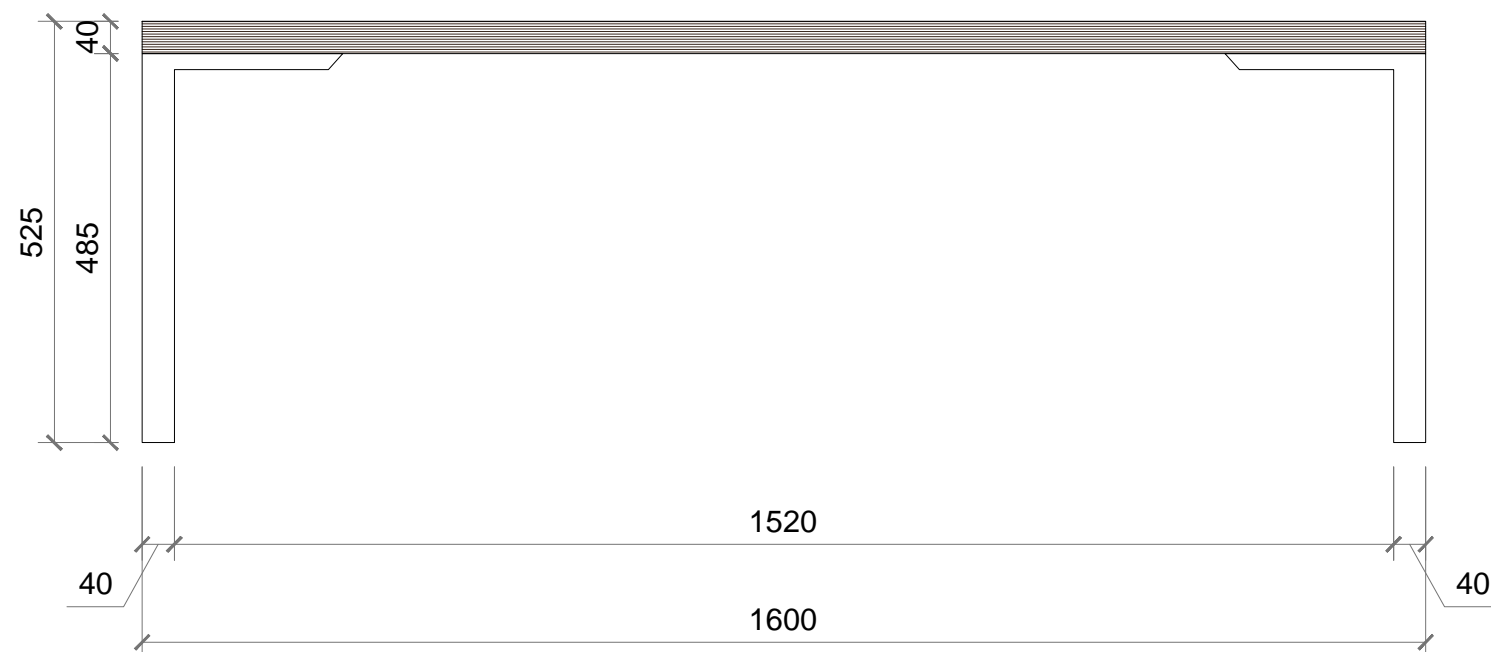

SĀNSKATS (B)

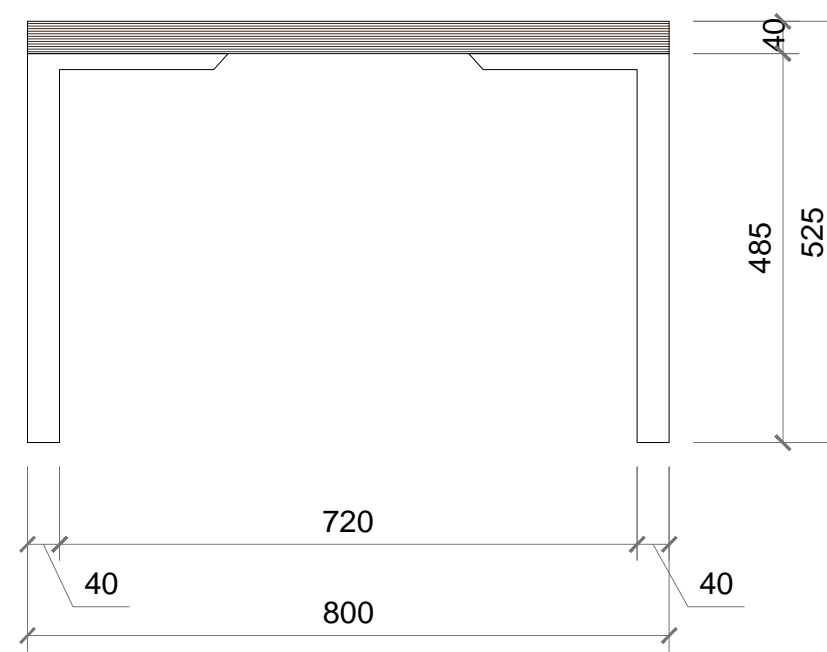

MATERIĀLI:

GALDA KĀJAS	KRĀSOTS METĀLS - tonis MELNS
GALDA VIRSMA	LAMINĒTA KOKSKAIDU PLĀTNE 40 MM. TONIS -TUMŠS KOKS, PIESKAŅOTS KABINETA MĒBELĒM.

- PIEZĪMES:
1. VISI IZMĒRI DOTI MILIMETROS.
 2. PIRMS IZGATAVOŠANAS VISUS IZMĒRUS NEPIECIEŠAMS PĀRMĒRĪT OBJEKTĀ UZ VIETAS.
 3. * GALDA IZMĒRUS PIRMS IZGATAVOŠANAS (1600*) SASKAŅOT AR DĪVĀNA GARUMU.
 4. ŅEMOT VĒRĀ GALDA GARUMU, IZSTRĀDĀTĀJAM JĀPAREDZ VIRSMAS STIPRINĀJUMS PRET LOČTŠANOS.

	OBJEKTS:	KULDĪGAS PROKURATŪRA	
	PASŪTĪTĀJS:	-	
IZSTRĀDĀJA:	L. LEJA	GALDS ZEMĀIS G- 160 1600x525x800	Stadija IN
			Mērogs 1:100
			Datums 05.07.2017