



Skapja regulējams balsts stiprinās pie cokola ar kronšteinu

LKSP 10 mm aizmugure - iegrieztā mugura

Izmantojamie materiāli:

Karkass	Lamināts Kronospan BO 375 PR	
	Malu apdare ar 2mm ABS malu	
Aizmugure	LKSP 10 mm aizmugure ar tekstūru	
Cokols	Skapja balsts ar stiprinājumu regulējams HAFELE Art. 637.37.904	

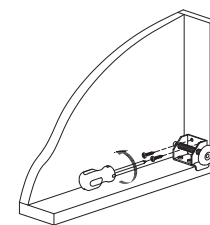

Dokumentu skapis - DSK 1-80

800 x 400 x H 2010

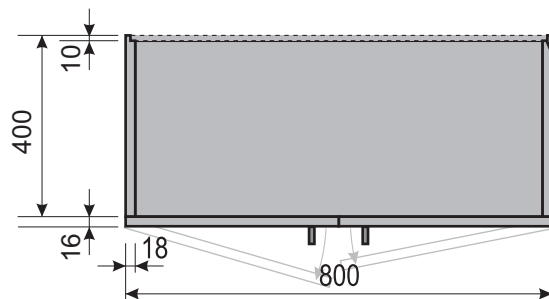
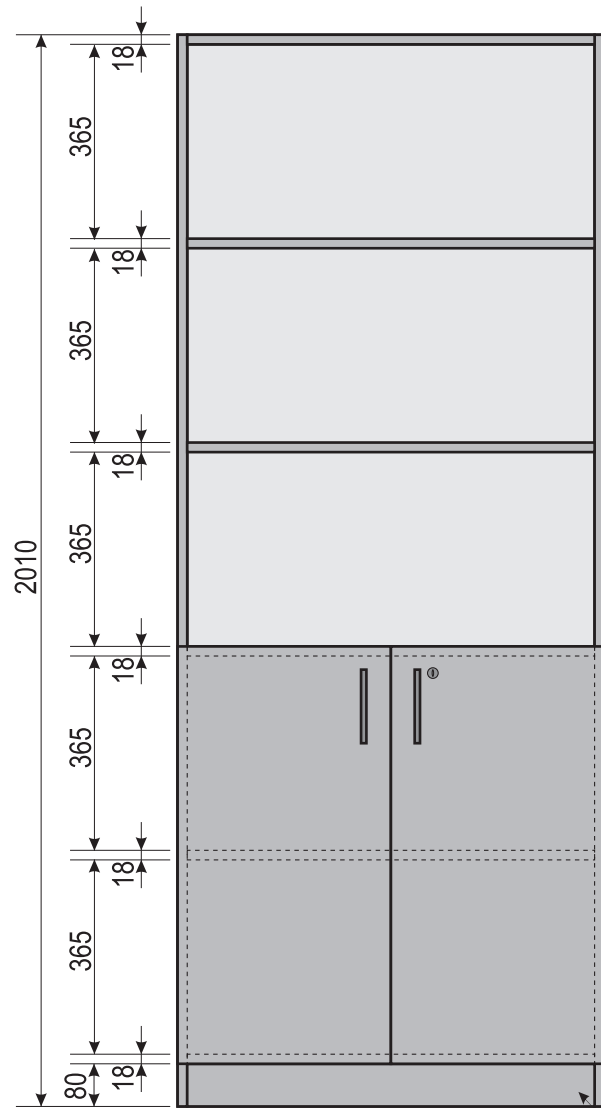

Skapja regulējams balsts stiprinās pie cokola ar kronšteinu

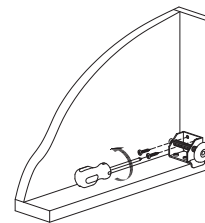
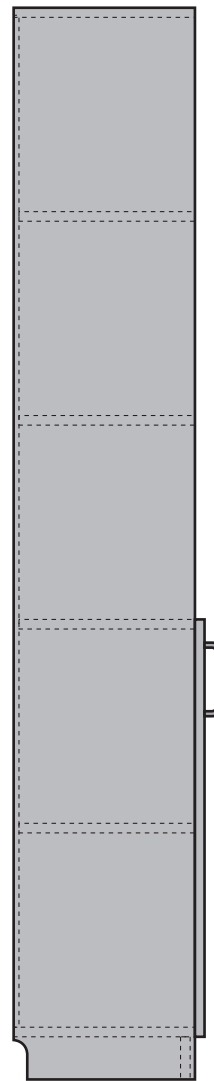

LKSP 10 mm aizmugure - iegriezta mugura



Izmantojamie materiāli:

Karkass	Lamināts Kronospan BO 375 PR Malu apdare ar 2mm ABS malu	
Aizmugure	LKSP 10 mm aizmugure ar tekstūru	
Cokols	Skapja balsts ar stiprinājumu regulējams HAFELE Art. 637.37.904	
Vērtnes	Lamināts Kronospan BO 375 PR Malu apdare ar 2mm ABS malu	
Rokturi	Hafele Rokturis skava mat. ņik. 128 Art. 116.05.942 10/138x32mm	
Enģes	Blum Clip enģes, klusa aizvēršana, 110° Art. 71B3550	
Vērtņu aizvēršanas amortizatori	Silikona amortizatori	

Papildus:

Slēdzene	HAFELE Art. 232.01.220	
Aizbīdnis	HAFELE Pretplāksnīte aizbīdnim Art. 251.74.707	

Dokumentu skapis - DSK 2-80  
800 x 400 x H 2010

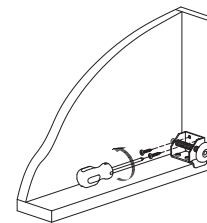
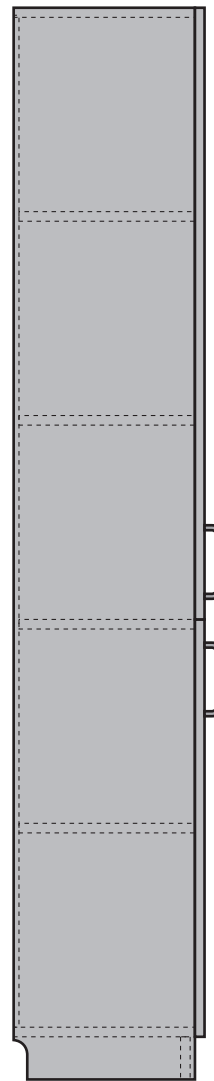
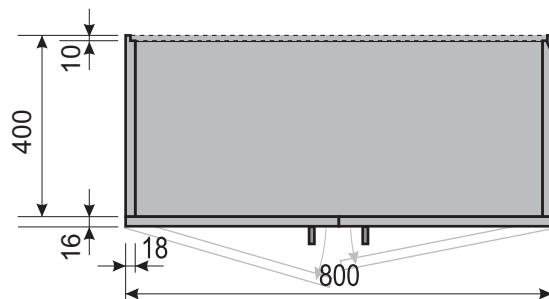
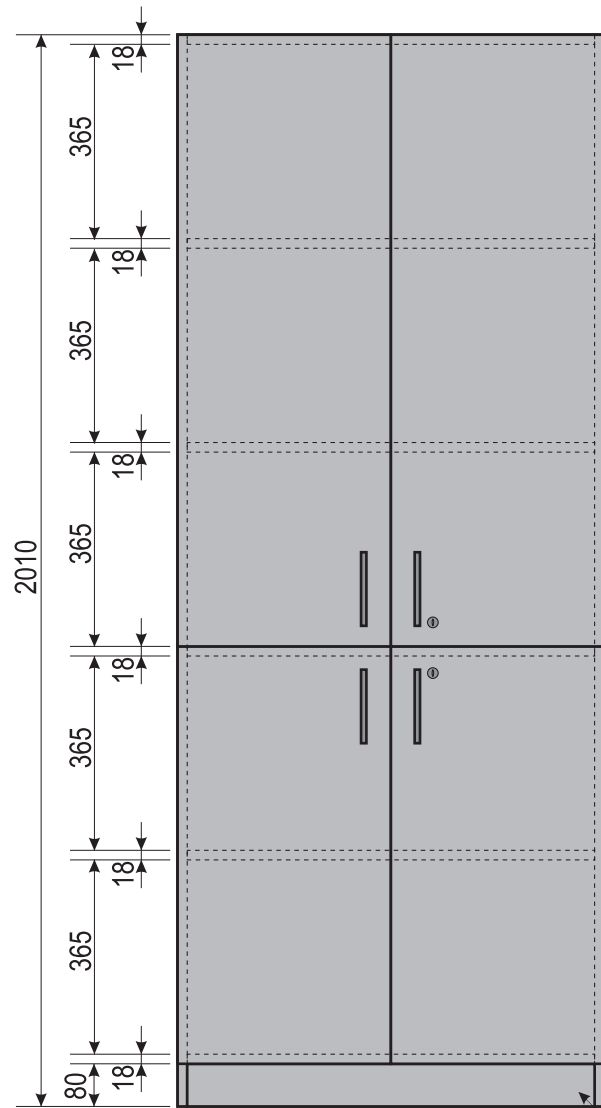

Skapja regulējams balsts stiprinās pie cokola ar kronšteinu

LKSP 10 mm aizmugure - iegrieztā mugura

Izmantojamie materiāli:

Karkass	Lamināts Kronospan BO 375 PR Malu apdare ar 2mm ABS malu	
Aizmugure	LKSP 10 mm aizmugure ar tekstūru	
Cokols	Skapja balsts ar stiprinājumu regulējams HAFELE Art. 637.37.904	
Vērtnes	Lamināts Kronospan BO 375 PR Malu apdare ar 2mm ABS malu	
Rokturi	HAFELE Rokturis skava mat. ņik. 128 mm Art. 116.05.942 10/138x32mm	
Enģes	BLUM Clip enģes, klusa aizvēršana, 110° Art. 71B3550	
Vērtņu aizvēršanas amortizatori	Silikona amortizatori	

Papildus

Slēdzene	HAFELE Art. 232.01.220	
Aizbīdnis	HAFELE Pretplāksnīte aizbīdnim Art. 251.74.707	

Dokumentu skapis - DSK 3-80

800 x 400 x H 2010

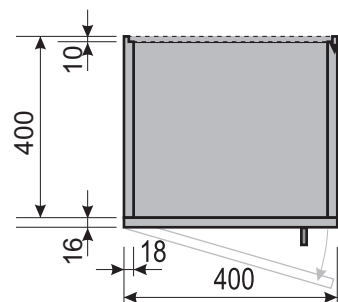
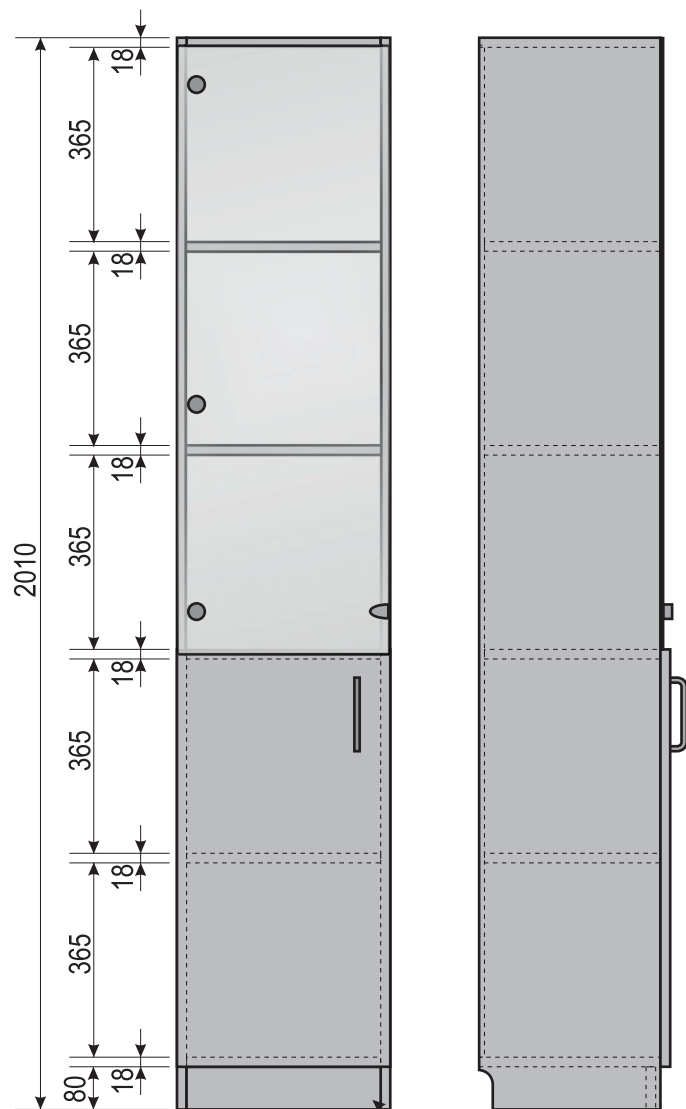

Skapja regulējams balsts stiprinās pie cokola ar kronšteinu

LKSP 10 mm aizmugure - iegrieztā mugura

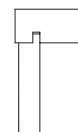
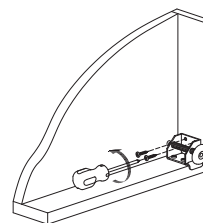

Izmantojamie materiāli:

Karkass	Lamināts Kronospan BO 375 PR Malu apdare ar 2mm ABS malu	
Aizmugure	LKSP 10 mm aizmugure ar tekstūru	
Cokols	Skapja balsts ar stiprinājumu regulējams HAFELE Art. 637.37.904	
Vērtnes	Lamināts Kronospan BO 375 PR Malu apdare ar 2mm ABS malu	
Rokturi	HAFELE Rokturis skava mat. ņik. 128 mm Art. 116.05.942 10/138x32mm	
Enģes	Blum Clip enģes, klusa aizvēršana, 110° Art. 71B3550	
Vērtņu aizvēršanas amortizatori	Silikona amortizatori	
Enģes stikla vērtnēm	BLUM CLIP top stikla vira, pusuzliktā Art. 75T4200 BLUM stikla viras uzlika, niķelēta, matēta Art. 84.4140.MANI	
Stikls	5mm biezs, ar caurspīdīgu aizsargplēvi	
Rokturi stikla durvīm	Rokturis stikla durvīm, alumīnijs SISO Art. 17.40.051	

Dokumentu skapis - DSK 5-40

400 x 400 x H 2010

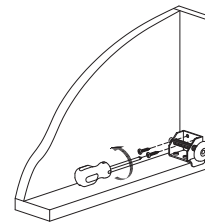
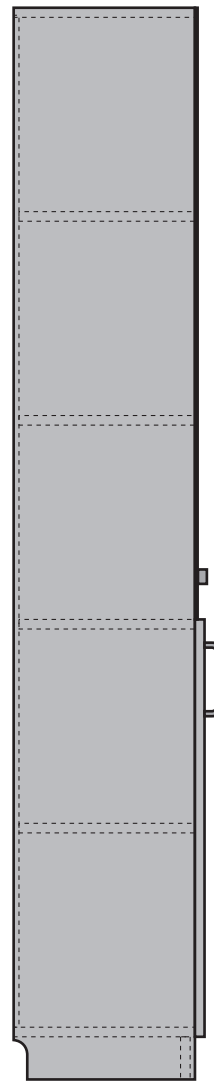
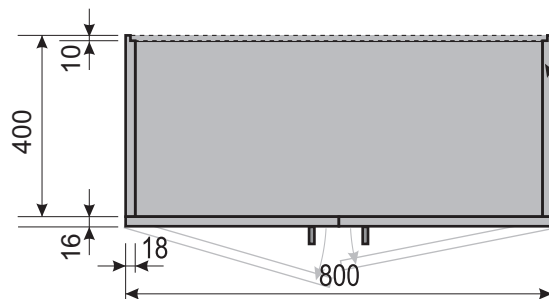
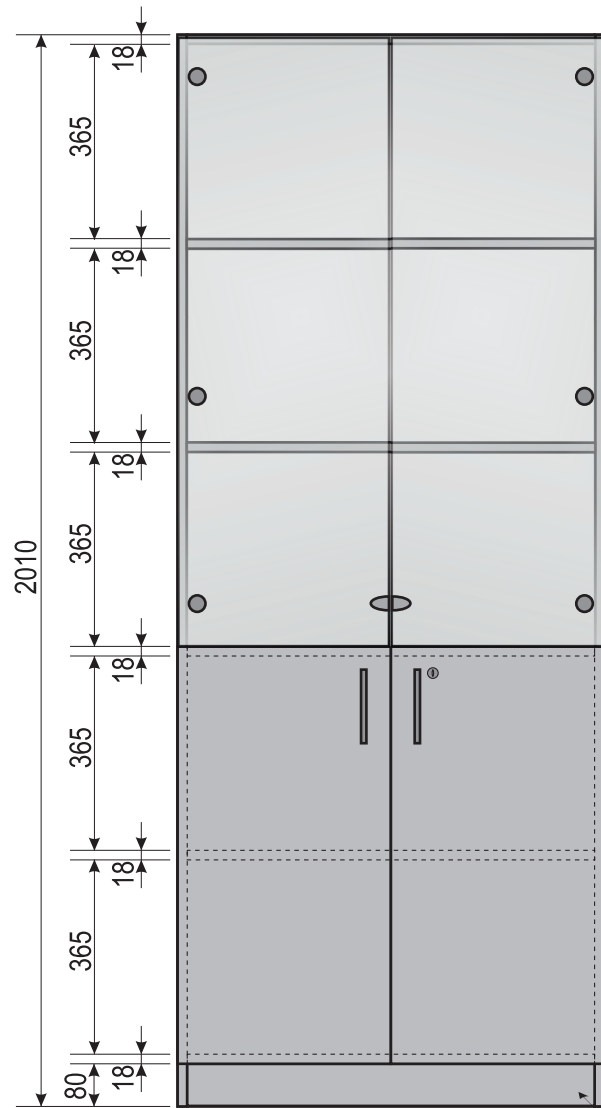

Skapja regulējams balsts stiprinās pie cokola ar kronšteinu

LKSP 10 mm aizmugure - iegriezta mugura

Izmantojamie materiāli:

Karkass	Lamināts Kronospan BO 375 PR Malu apdare ar 2mm ABS malu	
Aizmugure	LKSP 10 mm aizmugure ar tekstūru	
Cokols	Skapja balsts ar stiprinājumu regulējams HAFELE Art. 637.37.904	
Vērtnes	Lamināts Kronospan BO 375 PR Malu apdare ar 2mm ABS malu	
Rokturi	HAFELE Rokturis skava mat. ņik. 128 mm Art. 116.05.942 10/138x32mm	
Enģes	Blum Clip enģes, klusa aizvēršana, 110° Art. 71B3550	
Vērtņu aizvēršanas amortizatori	Silikona amortizatori	
Enģes stikla vērtnēm	BLUM CLIP top stikla vira, pusuzliktā Art. 75T4200 BLUM stikla viras uzlika, niķelēta, matēta Art. 84.4140.MANI	
Stikls	5mm biezs, ar caurspīdīgu aizsargplēvi	
Rokturi stikla durvīm	Rokturis stikla durvīm, alumīnijs SISO Art. 17.40.051	
Papildus:		
Slēdzene	HAFELE Art. 232.01.220	
Aizbīdnis	HAFELE Pretplāksnīte aizbīdnim Art. 251.74.707	

Dokumentu skapis - DSK 5-80

800 x 400 x H 2010

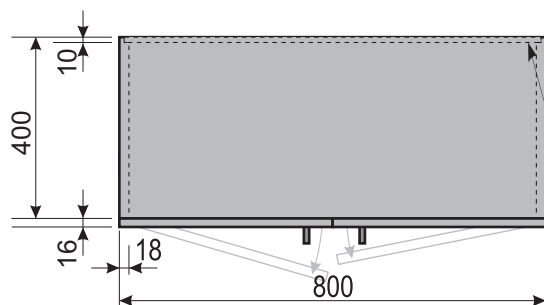
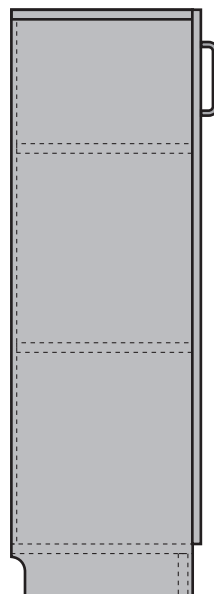
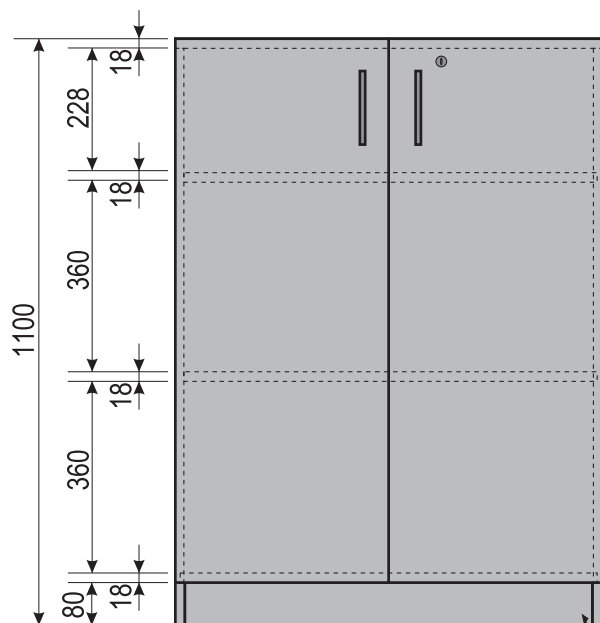

Skapja regulējams balsts  
stiprinās pie cokola ar kronšteinu

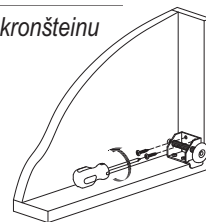



LKSP 10 mm aizmugure - iegrieztā mugura

Izmantojamie materiāli:

Karkass	Lamināts Kronospan BO 375 PR Malu apdare ar 2mm ABS malu	
Aizmugure	LKSP 10 mm aizmugure ar tekstūru	
Cokols	Skapja balsts ar stiprinājumu regulējams HAFELE Art. 637.37.904	
Vērtnes	Lamināts Kronospan BO 375 PR Malu apdare ar 2mm ABS malu	
Rokturi	HAFELE Rokturis skava mat. ņik. 128 mm Art. 116.05.942 10/138x32mm	
Enģes	Blum Clip enģes, klusa aizvēršana, 110° Art. 71B3550	
Vērtņu aizvēršanas amortizatori	Silikona amortizatori	

Papildus:

Slēdzene	HAFELE Art. 232.01.220	
Aizbīdnis	HAFELE Pretplāksnīte aizbīdnim Art. 251.74.707	

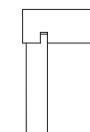

Dokumentu skapis - DSK 8-80  
800 x 400 x H 1100

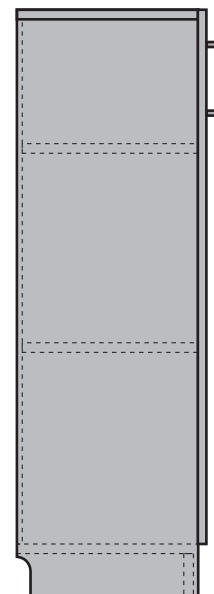
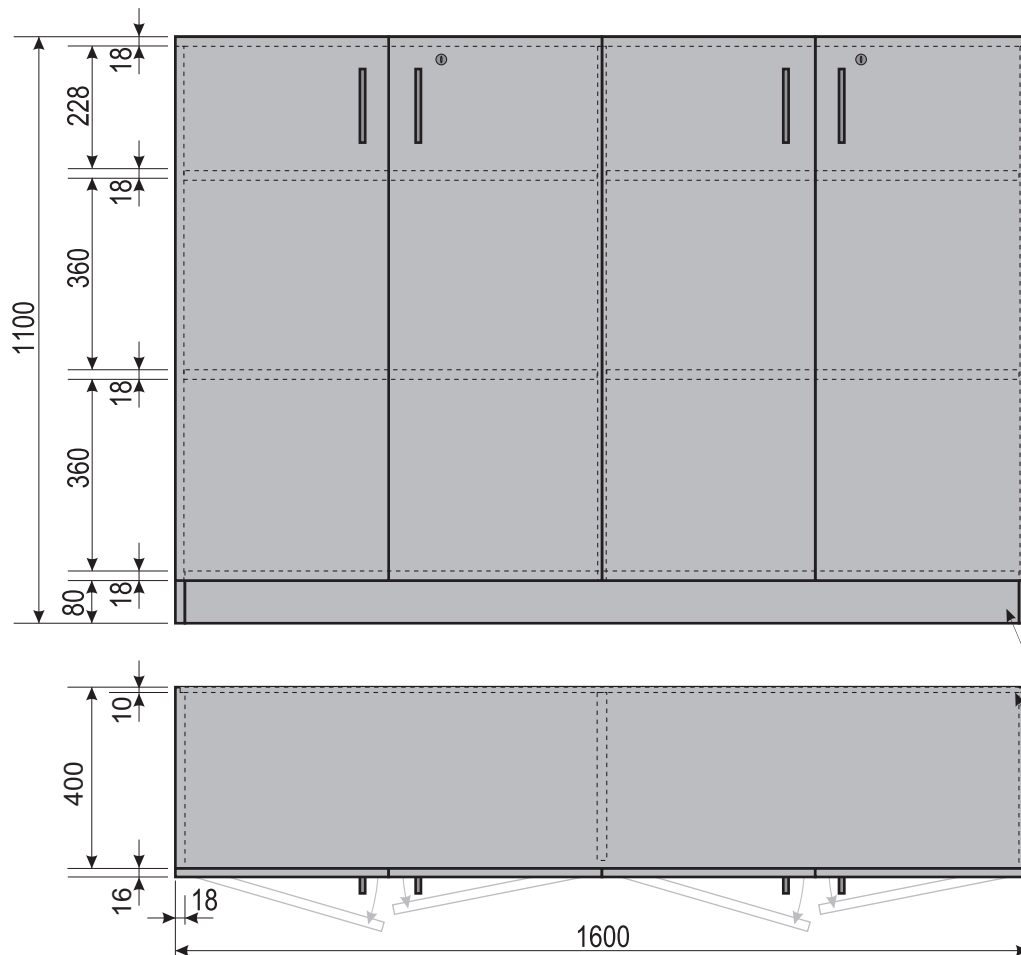

Skapja regulējams balsts stiprinās pie cokola ar kronšteinu

LKSP 10 mm aizmugure - iegriezta mugura

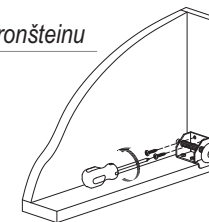
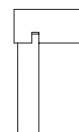

Izmantojamie materiāli:

Karkass	Lamināts Kronospan BO 375 PR Malu apdare ar 2mm ABS malu	
Aizmugure	LKSP 10 mm aizmugure ar tekstūru	
Cokols	Skapja balsts ar stiprinājumu regulējams HAFELE Art. 637.37.904	
Vērtnes	Lamināts Kronospan BO 375 PR Malu apdare ar 2mm ABS malu	
Rokturi	HAFELE Rokturis skava mat. ņik. 128 mm Art. 116.05.942 10/138x32mm	
Enģes	Blum Clip enģes, klusa aizvēršana, 110° Art. 71B3550	
Vērtņu aizvēršanas amortizatori	Silikona amortizatori	

Papildus:

Slēdzene	HAFELE Art. 232.01.220	
Aizbīdnis	HAFELE Pretplāksnīte aizbīdnim Art. 251.74.707	

Dokumentu skapis - DSK 8-160

1600 x 400 x H 1100

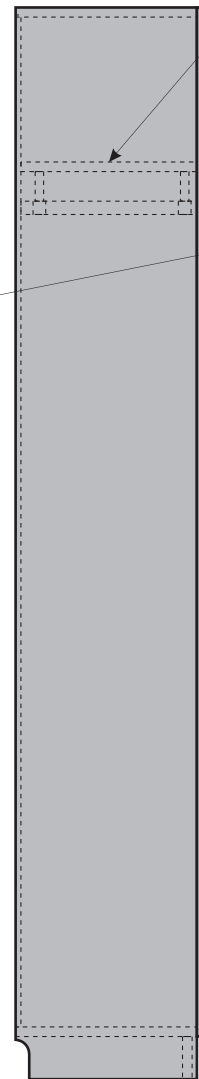
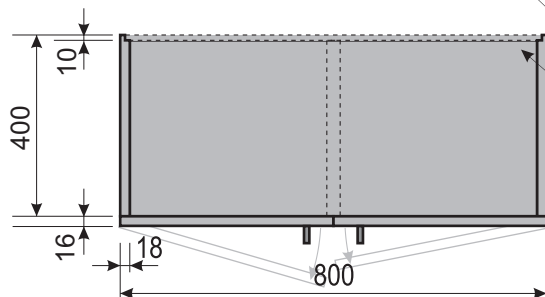
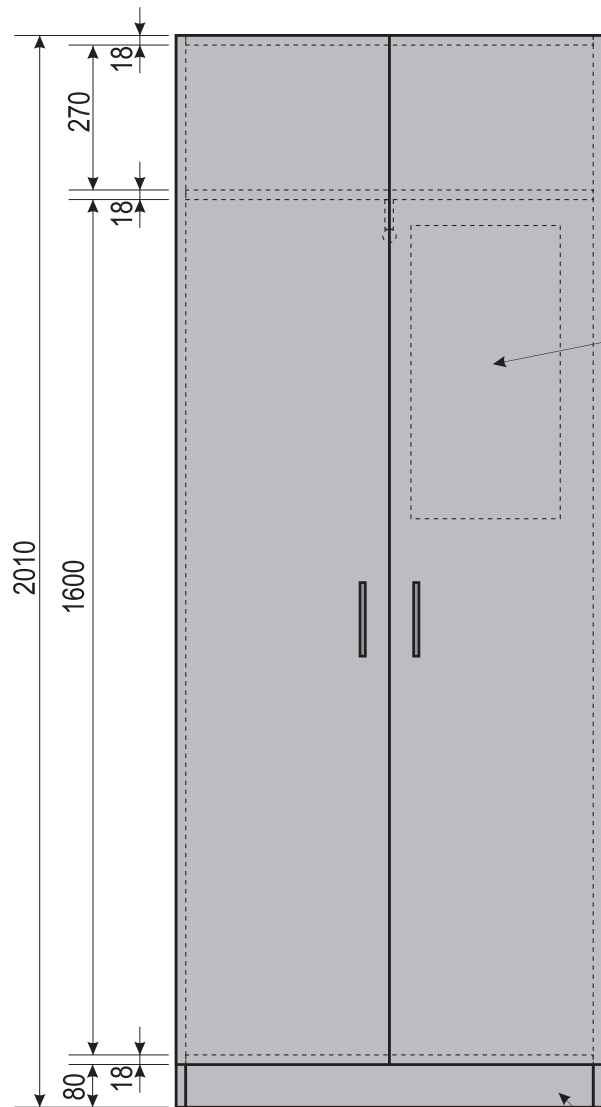

Jābūt iespējai šim plauktam ar drēbju pakaramo stieni mainīt atrašanās vietu - paredzot stiprinājuma vietas uz augšu no norādītās vietas

Spogulis 280x550mm skapja iekšpusē uz durvju vērtnes

Skapja regulējams balsts stiprinās pie cokola ar kronšteinu

LKSP 10 mm aizmugure - iegrieztā mugura

Izmantojamie materiāli:

Karkass	Lamināts Kronospan BO 375 PR Malu apdare ar 2mm ABS malu	
Aizmugure	LKSP 10 mm aizmugure ar tekstūru	
Cokols	Skapja balsts ar stiprinājumu regulējams HAFELE Art. 637.37.904	
Vērtnes	Lamināts Kronospan BO 375 PR Malu apdare ar 2mm ABS malu	
Rokturi	HAFELE Rokturis skava mat. ņik. 128 mm Art. 116.05.942 10/138x32mm	
Enģes	Blum Clip enģes, klusa aizvēršana, 110° Art. 71B3550	
Vērtņu aizvēršanas amortizatori	Silikona amortizatori	
Drēbju pakaramais	HAFELE ovālās caurules 30x15 Art. 342.11.0 HAFELE ovālās caurules turētājs Art. 802.07.200 HAFELE ovālās caurules gala korķis Art. 589.403.10.034	
Spoguļa turētājs	HAFELE Art. 292.01.710	

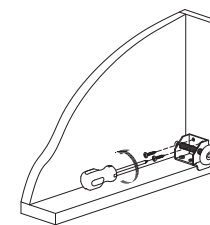

Apģērbu skapis - ASK 1-80  
800 x 400 x H 2010



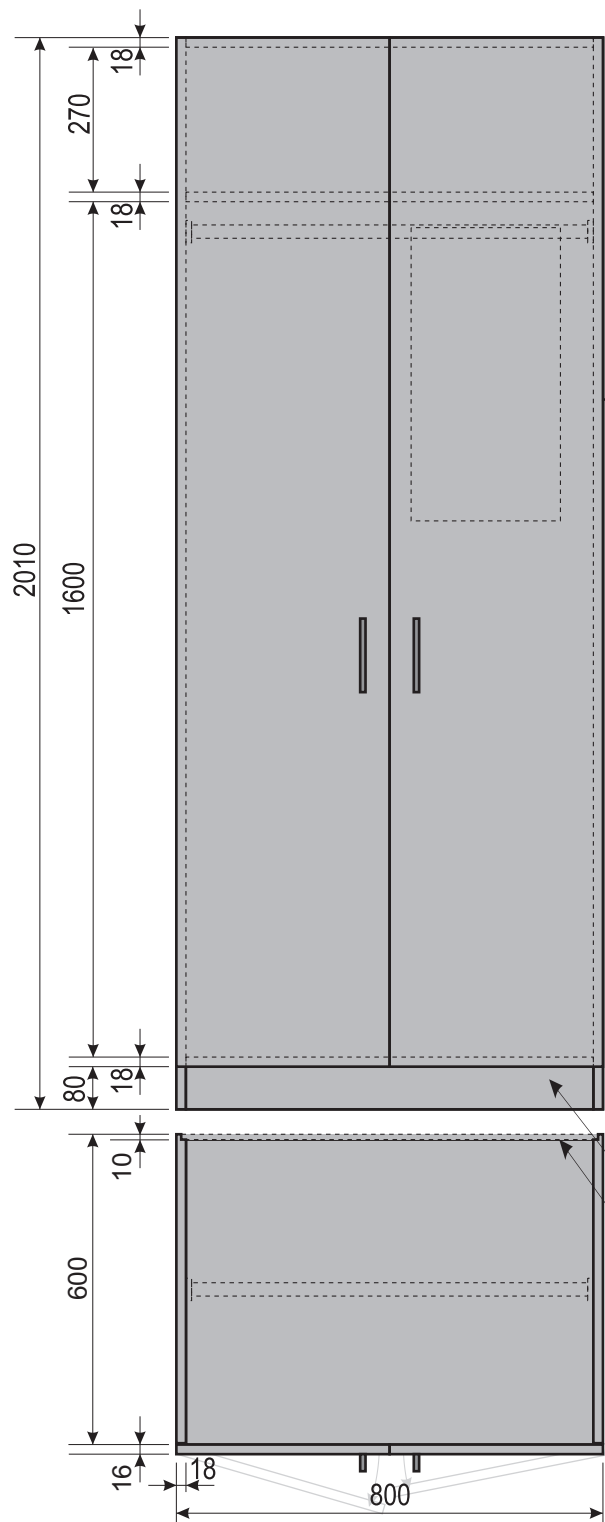

Jābūt iespējai šim plauktam ar drēbju pakaramo stieni mainīt atrašanās vietu - paredzot stiprinājuma vietas uz augšu no norādītās vietas

Spogulis 280x550mm  
skapja iekšpusē uz durvju vērtnes

Skapja regulējams balsts stiprinās pie cokola ar kronšteinu

LKSP 10 mm aizmugure - iegrieztā mugura

Izmantojamie materiāli:

Karkass	Lamināts Kronospan BO 375 PR Malu apdare ar 2mm ABS malu	
Aizmugure	LKSP 10 mm aizmugure ar tekstūru	
Cokols	Skapja balsts ar stiprinājumu regulējams HAFELE Art. 637.37.904	
Vērtnes	Lamināts Kronospan BO 375 PR Malu apdare ar 2mm ABS malu	
Rokturi	HAFELE Rokturis skava mat. ņik. 128 mm Art. 116.05.942 10/138x32mm	
Enģes	Blum Clip enģes, klusa aizvēršana, 110° Art. 71B3550	
Vērtņu aizvēršanas amortizatori	Silikona amortizatori	
Drēbju pakaramais	25 mm caurule GIE-3007 tērauds, hromēts 25 mm caurules turētājs ar fiksāciju GTV Art. F466 tērauds, hromēts	 
Spoguļa turētājs	HAFELE Art. 292.01.710	

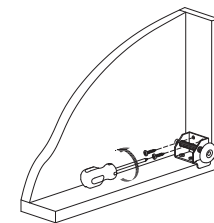
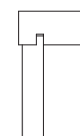

Apģērbu skapis - ASK 2-80  
800 x 600 x H 2010

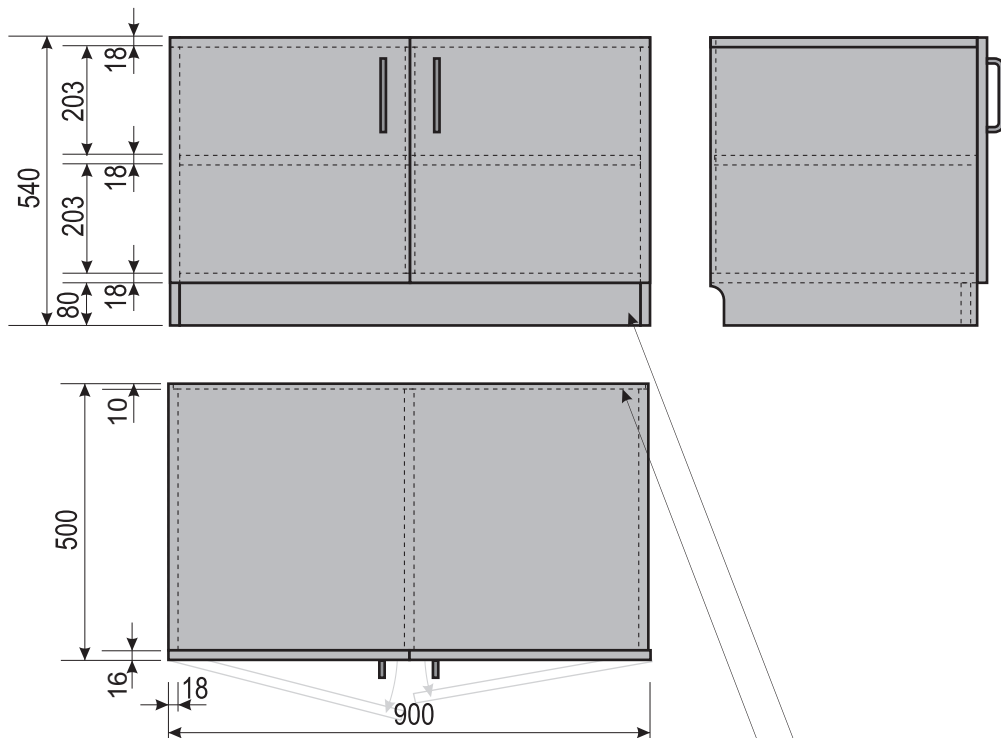

Izmantojamie materiāli:

Karkass	Lamināts Kronospan BO 375 PR Malu apdare ar 2mm ABS malu	
Aizmugure	LKSP 10 mm aizmugure ar tekstūru	
Cokols	Skapja balsts ar stiprinājumu regulējams HAFELE Art. 637.37.904	
Vērtnes	Lamināts Kronospan BO 375 PR Malu apdare ar 2mm ABS malu	
Rokturi	HAFELE Rokturis skava mat. ņik. 128 mm Art. 116.05.942 10/138x32mm	
Enģes	Blum Clip enģes, klusa aizvēršana, 110° Art. 71B3550	
Vērtņu aizvēršanas amortizatori	Silikona amortizatori	

Skapja regulējams balsts stiprinās pie cokola ar kronšteinu

LKSP 10 mm aizmugure - iegrieztā mugura

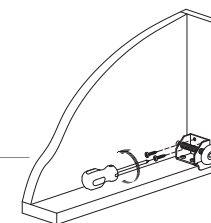

Kancelejas skapis - KSK 1-90

900 x 500 x H 540

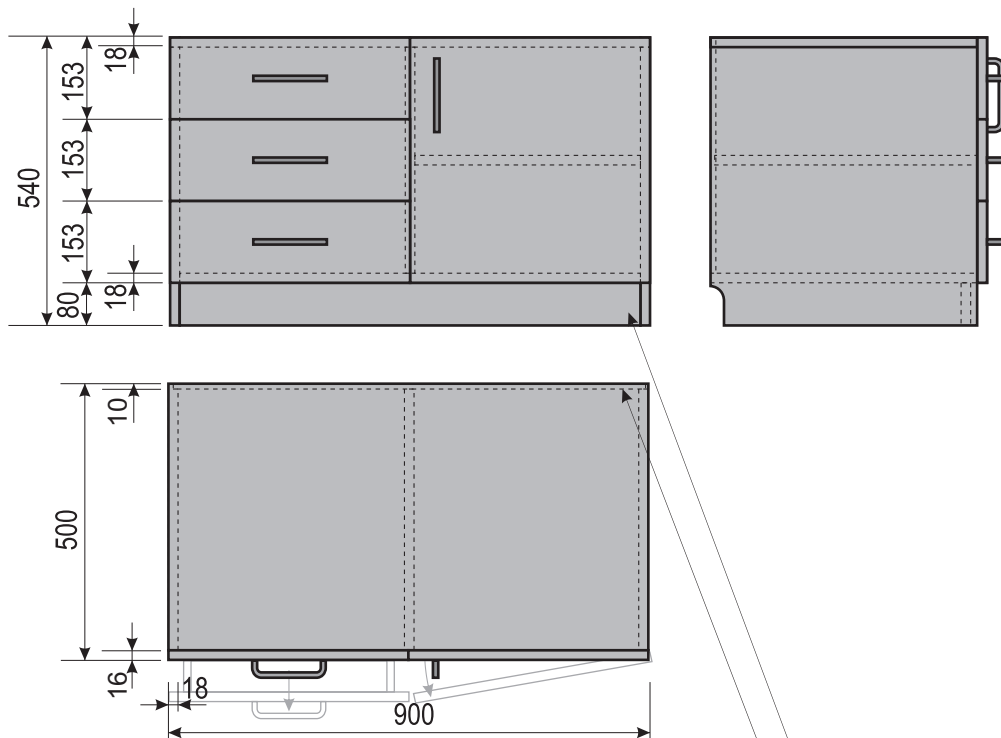

Izmantojamie materiāli:

Karkass	Lamināts Kronospan BO 375 PR Malu apdare ar 2mm ABS malu	
Aizmugure	LKSP 10 mm aizmugure ar tekstūru	
Cokols	Skapja balsts ar stiprinājumu regulējams HAFELE Art. 637.37.904	
Vērtnes	Lamināts Kronospan BO 375 PR Malu apdare ar 2mm ABS malu	
Rokturi	HAFELE Rokturis skava mat. ņik. 128 mm Art. 116.05.942 10/138x32mm	
Enģes	Blum Clip enģes, klusa aizvēršana, 110° Art. 71B3550	
Vērtņu aizvēršanas amortizatori	Silikona amortizatori	
Atvilktnu vadotnes	BLUM Metabox <i>piemērojot attiecīgās atvilktnes augstumam</i>	

Skapja regulējams balsts stiprinās pie cokola ar kronšteinu

LKSP 10 mm aizmugure - iegrieztā mugura

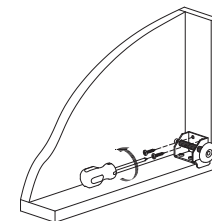
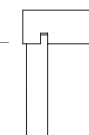

Kancelejas skapis - KSK 2-90

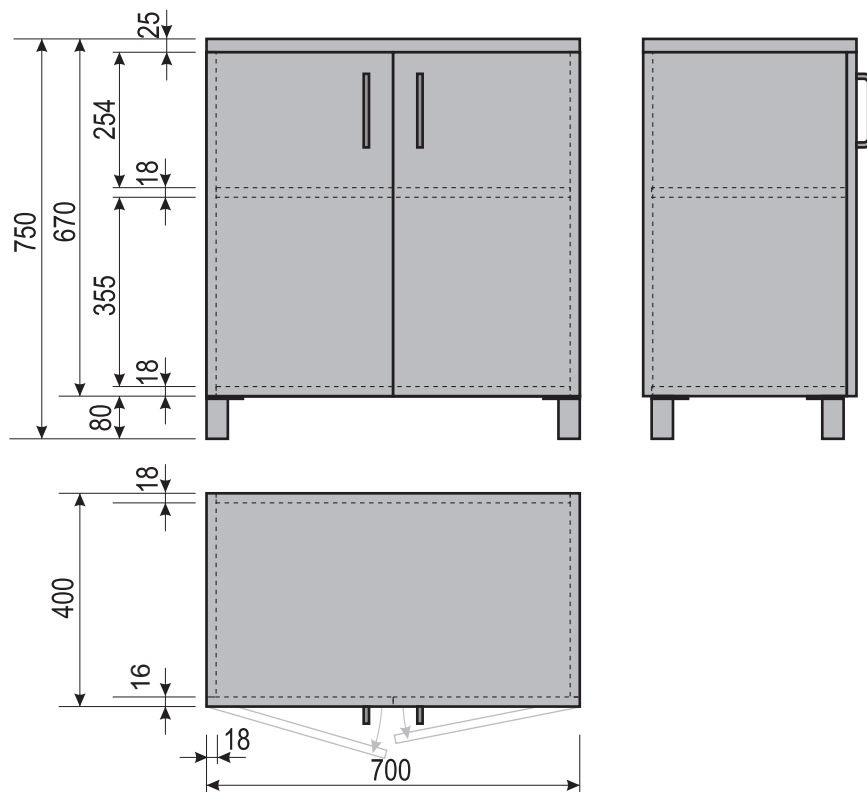

900 x 500 x H 540



Izmantojamie materiāli:

Karkass	Lamināts Kronospan BO 375 PR Malu apdare ar 2mm ABS malu	
Aizmugure	Lamināts Kronospan BO 375 PR	
Kājas	HAFELE Art. 634.74.461 alumīnija krāsa	
Vērtnes	Lamināts Kronospan BO 375 PR Malu apdare ar 2mm ABS malu	
Virsmā	Lamināts Kronospan BO 375 PR 25mm Malu apdare ar 2mm ABS malu	
Rokturi	HAFELE Rokturi skava mat. ņik. 128 mm Art. 116.05.942 10/138x32mm	
Enģes	Blum Clip enģes, klusa aizvēršana, 110° Art. 71B3550	
Vērtņu aizvēršanas amortizatori	Silikona amortizatori	

Papildus:

Slēdzene	HAFELE Art. 232.01.220	
Aizbīdnis	HAFELE Pretplāksnīte aizbīdnim Art. 251.74.707	

Dokumentu skapis pie galda - DSKG 1-70  
700 x 400 x H 750

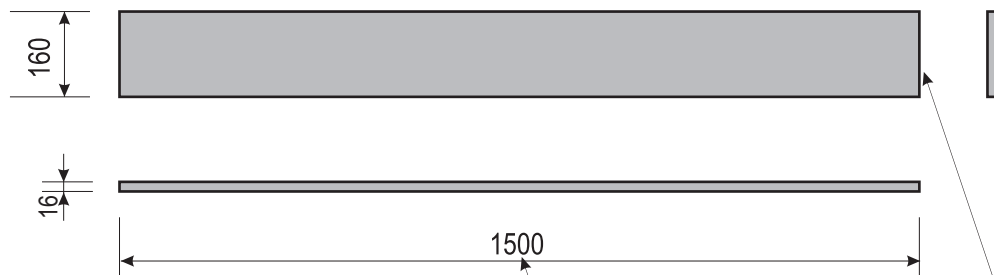

Izmantojamie materiāli:

Panelis	Lamināts Kronospan BO 375 PR 18 mm	
	Malu apdare ar 2mm ABS malu	

*Paneļa stiprinājums pie sienas - ideālā variantā - neredzams no fasādes puses, bet ja sienas reljefs to nepieļauj, tad - pieskrūvējot.  
Skrūvju nosegšanai izmantot - nosegplāksni, tonāli saskaņotu ar paneļa materiālu.*

*Sienas paneļa garums var tikt mainīts, pieskaņojot to konkrētai situācijai telpā*

Sienas panelis - SP-1

1500 x 18 x H 160

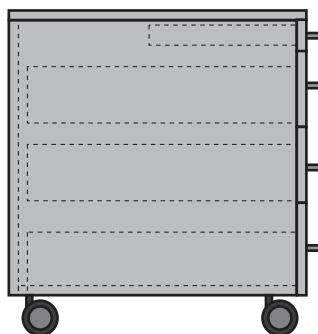
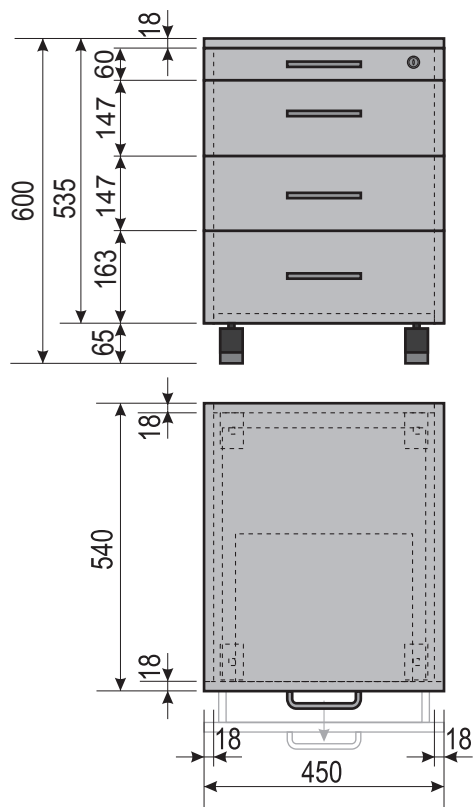

Korpuss sastiprināms ar savilcējiem,  
lai nebūtu no fasādes puses redzamas skrūvju vietas!

Izmantojamie materiāli:



Karkass	Lamināts Kronospan BO 375 PR Malu apdare ar 2mm ABS malu	
Aizmugure	Lamināts Kronospan BO 375 PR	
Atvilktnu priekša	Lamināts Kronospan BO 375 PR Malu apdare ar 2mm ABS malu	
Rokturi	HAFELE Rokturis skava mat. ņik. 128 mm Art. 116.05.942 10/138x32mm	
Atvilktnu vadotnes	BLUM Metabox <i>piemērojot attiecīgās atvilktnes augstumam</i>	
Atslēga	Slēdzene saslēdz visas atvilktnes ar vienu atslēgu HAFELE Art. 237.48.600	
Kancelejas atvilktnē	Augšējā atvilktnē piemērojams kancelejas sadalījums HAFELE Art. 818.04.051	
Riteņi	Priekšējie divi ar bremzi TENTE Art. 00.071.465  TENTE Art. 00.071.480	

Atvilktnu bloks - AB 1-45

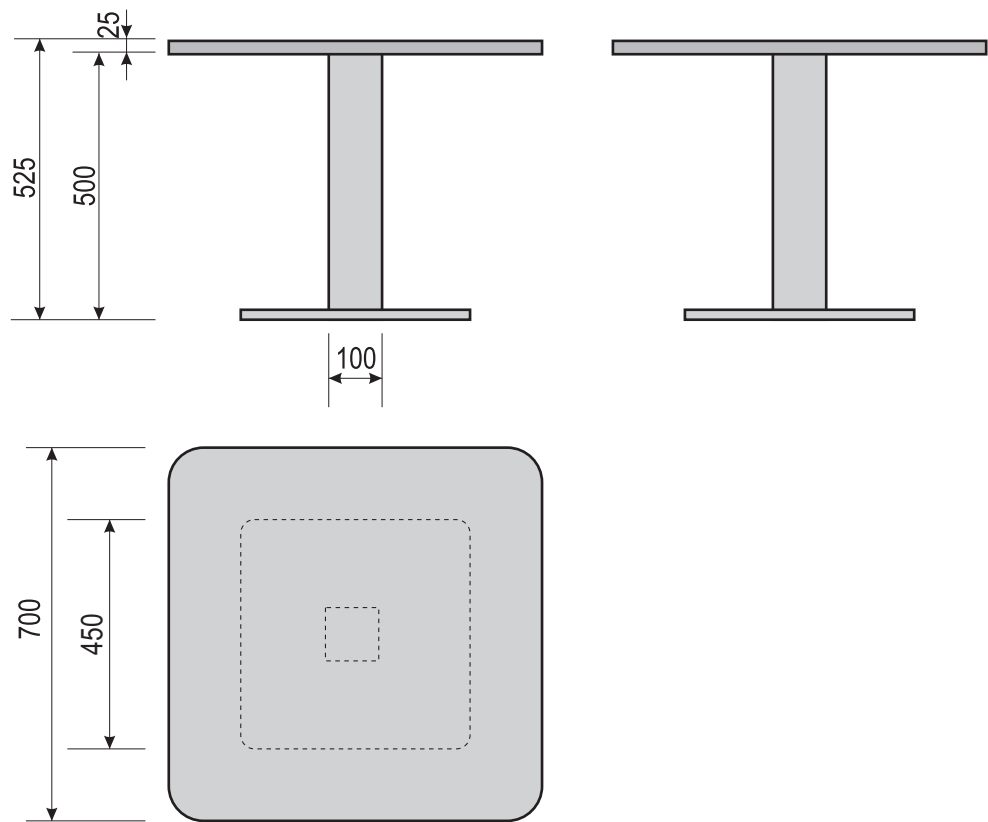
450 x 540 x H 600



Izmantojamie materiāli:



Galda virsma	Lamināts Kronospan BO 375 PR 25 mm Malu apdare ar 2mm ABS malu	
Galda kāja	Centrāla galda kāja, bāze 450 x 450mm, 60 x 60mm mebeles.lv Art. 17-0018 hromēta <i>vai hromēts analogs</i>	

Galds zemais - G-70

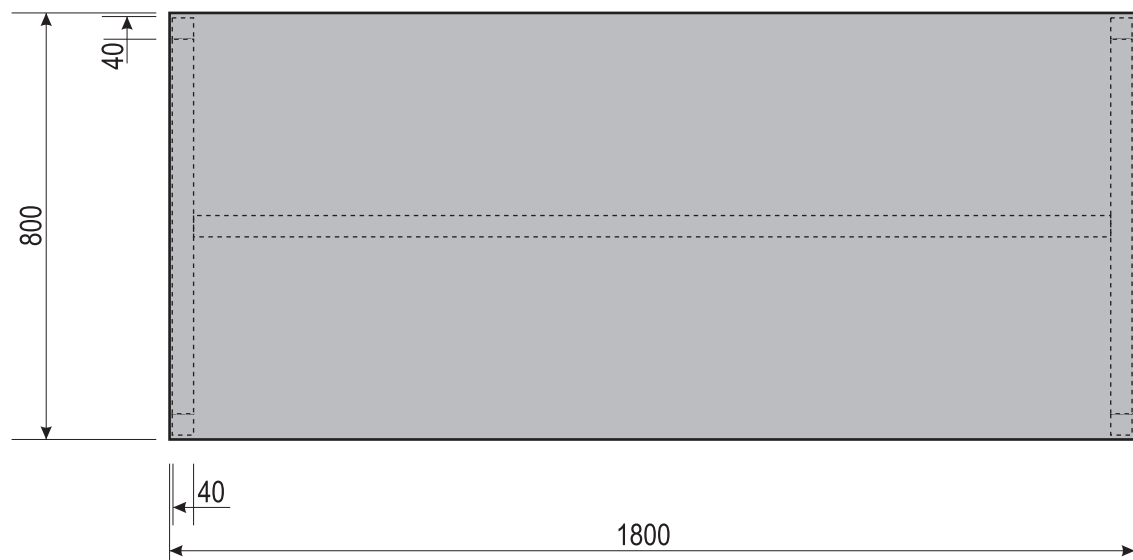
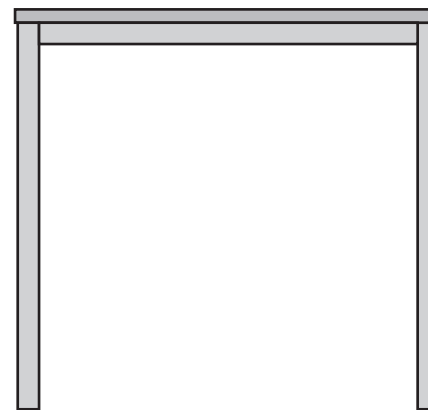
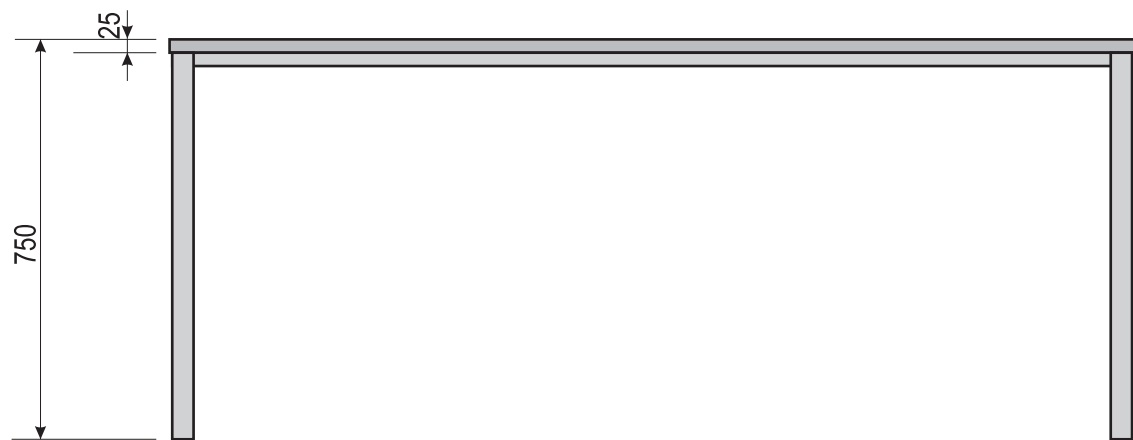
700 x 700 x H 525



Izmantojamie materiāli:

Galda virsma	Lamināts Kronospan BO 375 PR 25 mm	
	Malu apdare ar 2mm ABS malu	
Galda kājas	HAFELE Art. 633.11.269 garums 1800mm alumīnija krāsa	



Apspriežu galds - AG-180

1800 x 800 x H 750

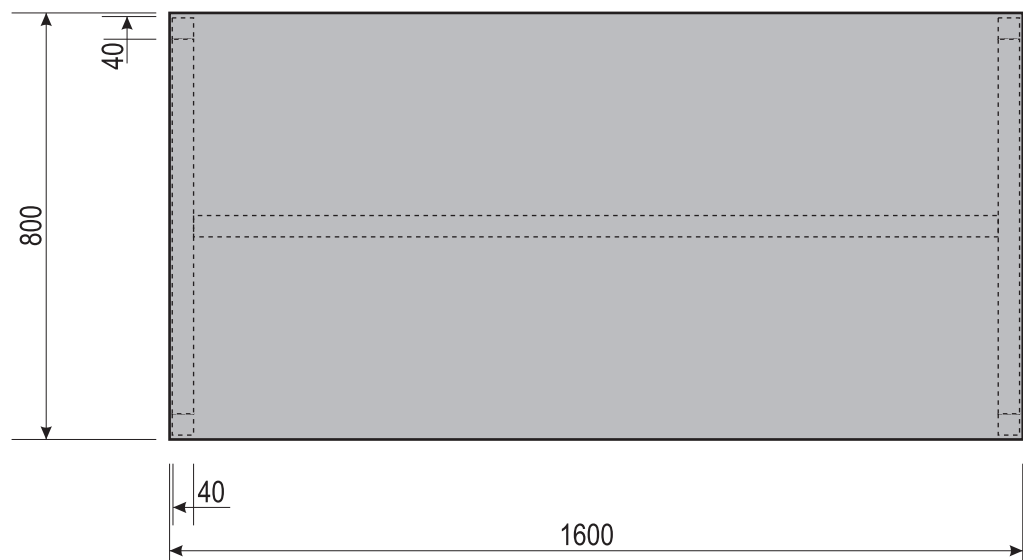
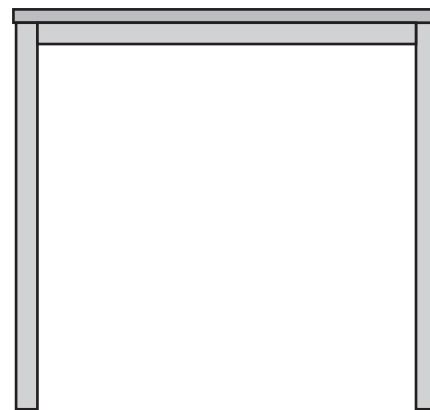



Izmantojamie materiāli:



Galda virsma	Lamināts Kronospan BO 375 PR 25 mm	
	Malu apdare ar 2mm ABS malu	
Galda kājas	HAFELE Art. 633.11.267 garums 1600mm RAL 9006 (alumīnija krāsa)	

Apspriežu galds - AG-160-1

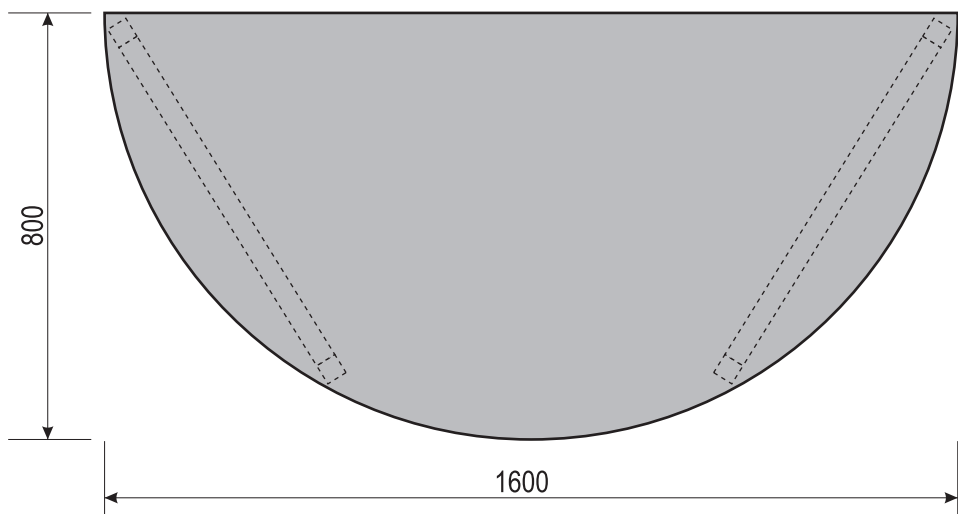
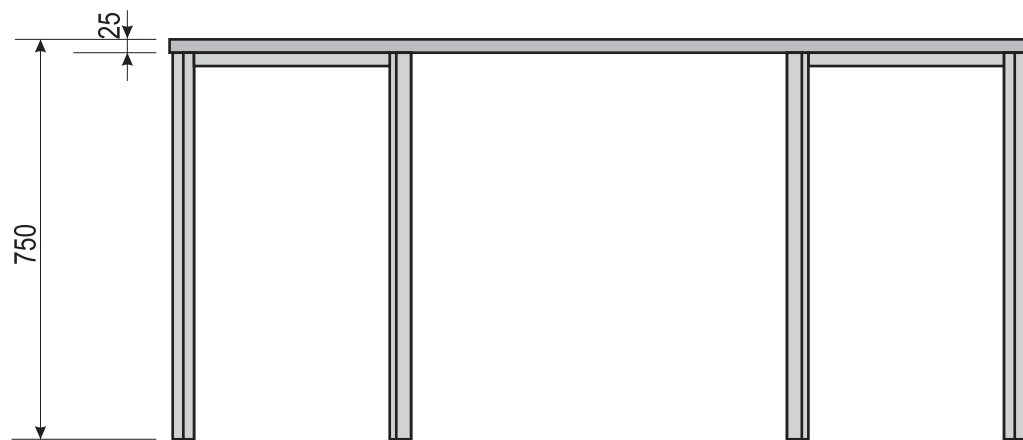
1600 x 800 x H 750



Izmantojamie materiāli:

Galda virsma	Lamināts Kronospan BO 375 PR 25 mm  Malu apdare ar 2mm ABS malu	
Galda kājas	HAFELE Art. 633.08.225 garums 800mm RAL 9006 (alumīnija krāsa)	
Galda virsmu savienotājs	HAFELE Art. 642.42.900	

Apspriežu galds - AG-160-2 (pusaplis)

1600 x 800 x H 750

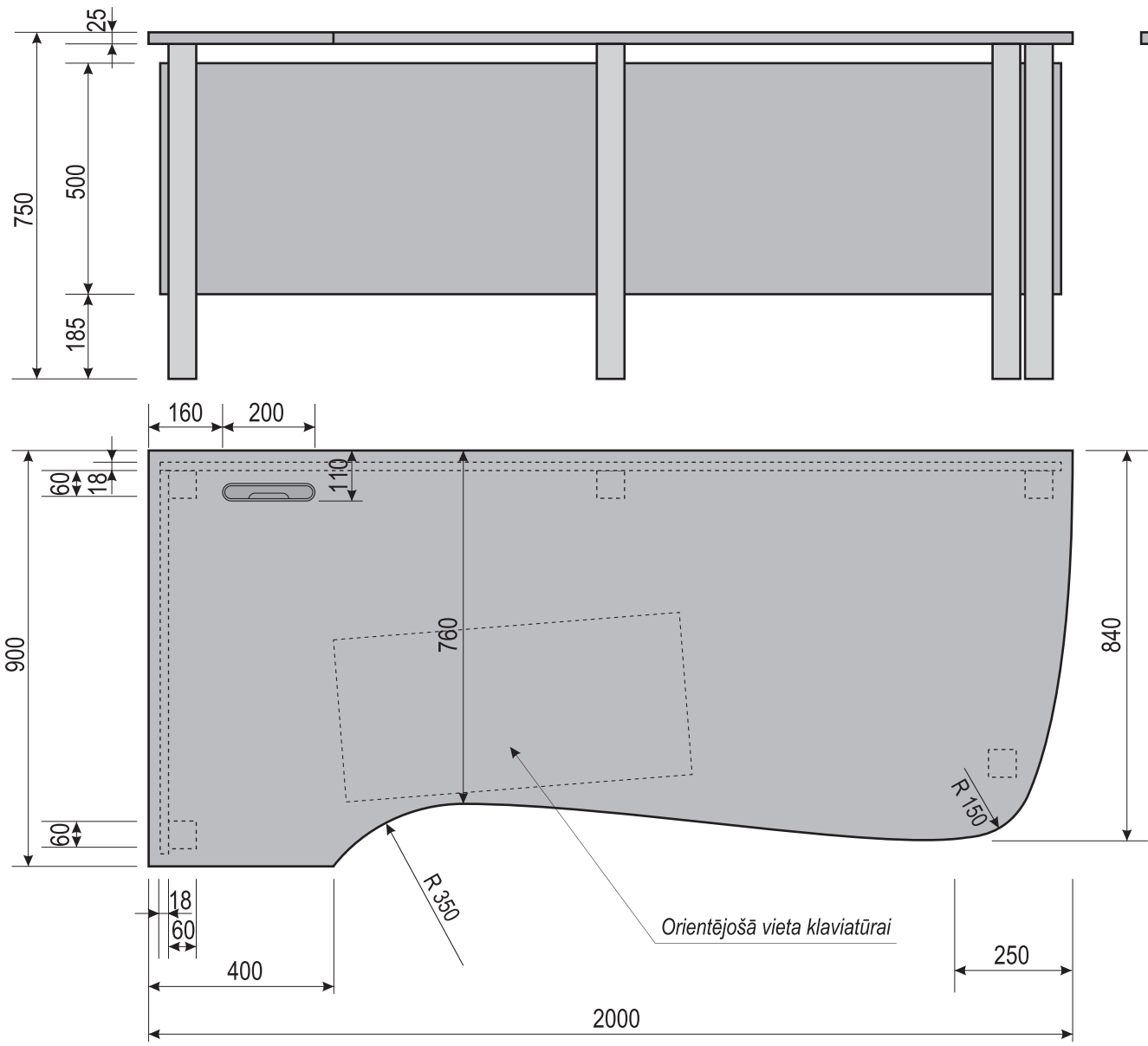

*Priekšējais kāju panelis stiprināms pie galda kājām - ar fiksatoriem (apaļa kāja) vai pieskrūvējot. Skrūvju noseģšanai izmantot - noseģplāksni, tonāli saskaņotu ar paneļa materiālu.*

Rakstāmgalds - RG-1L-2  
2000 x 900 x H 750

RG-1L-0

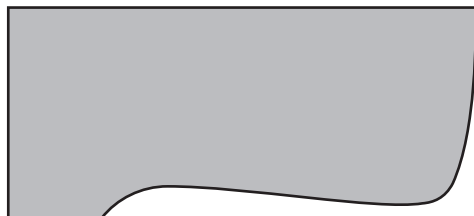

RG-1K-0

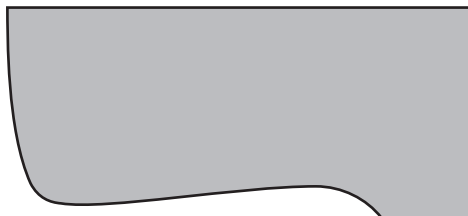

RG-1L-1

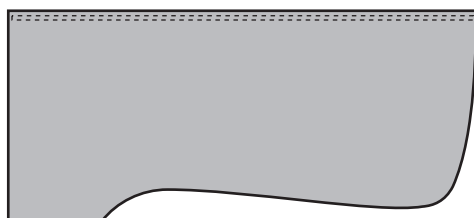

RG-1K-1

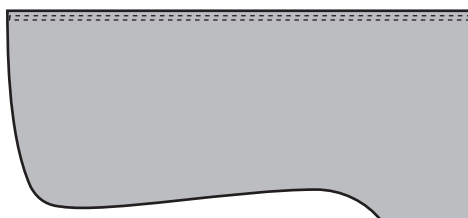



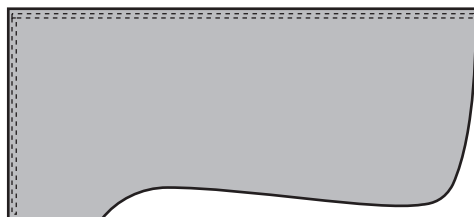

RG-1L-2

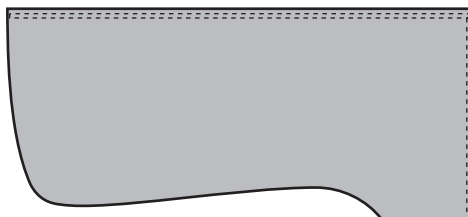

RG-1K-2



## Izmantojamie materiāli:

Galda virsma	Lamināts Kronospan BO 375 PR 25 mm Malu apdare ar 2mm ABS malu	
Panelis	Lamināts Kronospan BO 375 PR Malu apdare ar 2mm ABS malu	
Galda kājas	HAFELE Art. 635.59.906 vai HAFELE Art. 635.11.270 aluminija krāsa RAL 9006	
Pamatne klaviatūrai	Vadotnes HAFELE Art. 420.34.935 Lamināta virsma ar 2 mm ABS malu vai GTV Art. PU-KEYM27	
Kabeļu kanāls	HAFELE Art. 631.36.200	

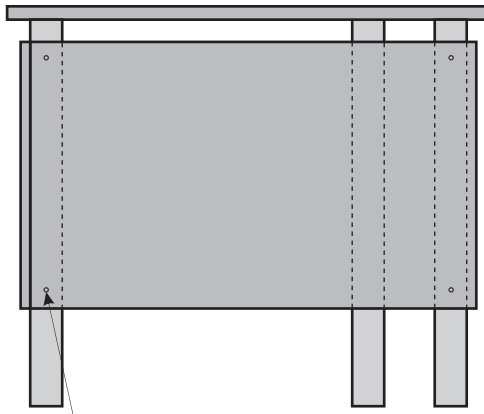
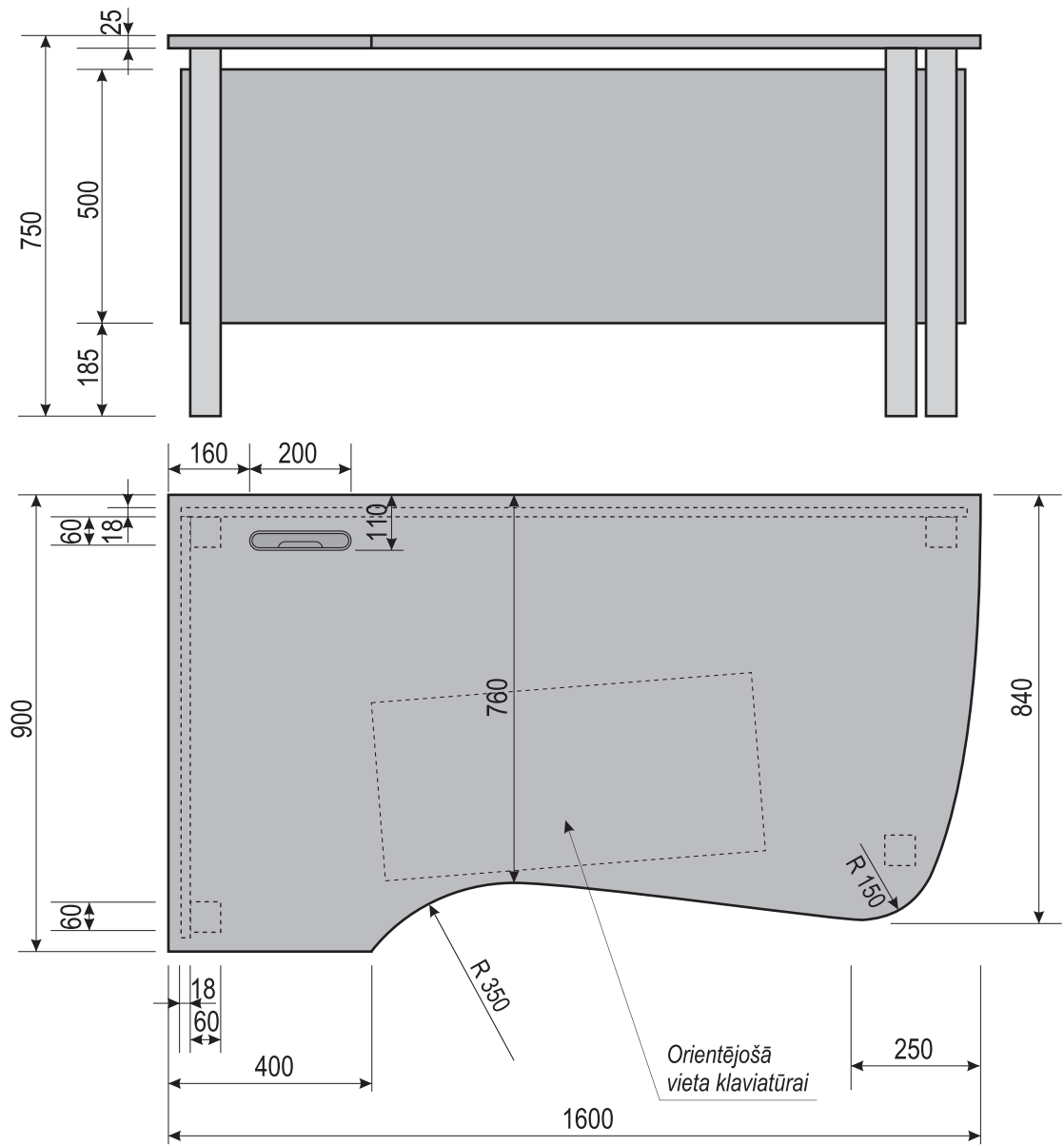

Priekšējais kāju panelis stiprināms pie galds kājām - ar fiksatoriem (apaļa kāja) vai pieskrūvējot.  
Skrūvju noseģšanai izmantot - noseģplāksni, tonāli saskaņotu ar paneļa materiālu.

Rakstāmgalds - RG-2L-2  
1600 x 900 x H 750

RG-2L-0

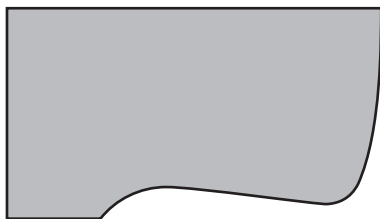

RG-2K-0

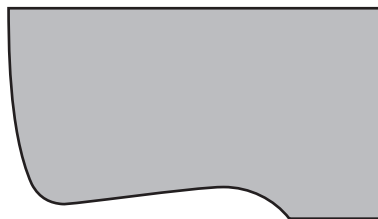

RG-2L-1

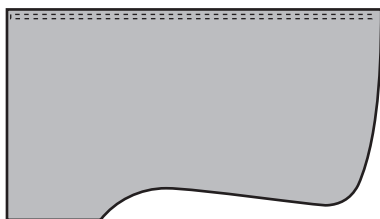

RG-2K-1

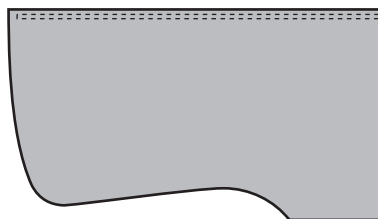



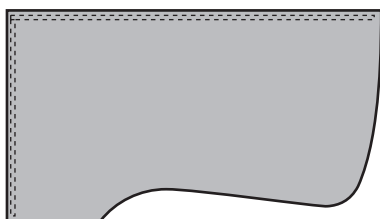

RG-2L-2

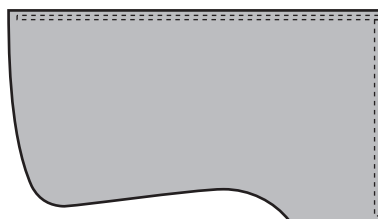

RG-2K-2



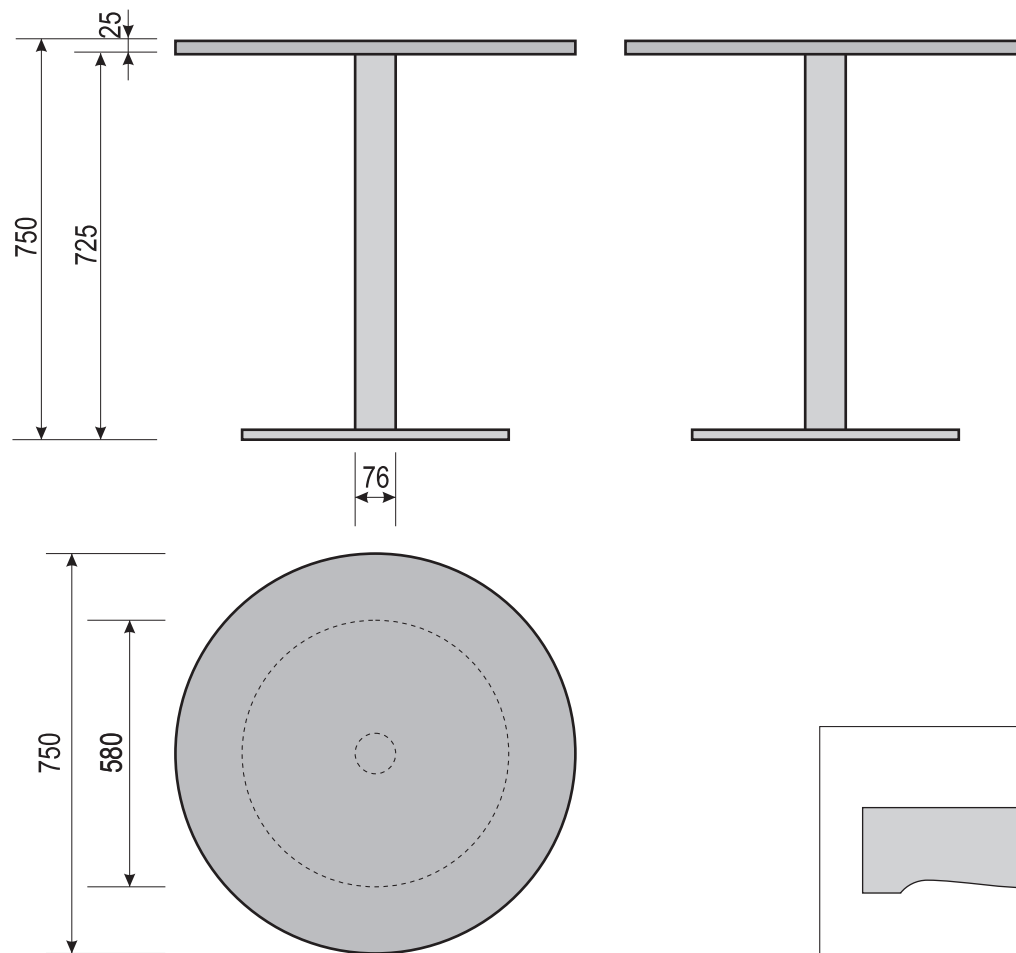

## Izmantojamie materiāli:

Galda virsma	Lamināts Kronospan BO 375 PR 25 mm Malu apdare ar 2mm ABS malu	
Panelis	Lamināts Kronospan BO 375 PR Malu apdare ar 2mm ABS malu	
Galda kājas	HAFELE Art. 635.59.906 vai HAFELE Art. 635.11.270 aluminija krāsa RAL 9006	
Pamatne klaviatūrai	Vadotnes HAFELE Art. 420.34.935 Lamināta virsma ar 2 mm ABS malu vai GTV Art. PU-KEYM27	
Kabeļu kanāls	HAFELE Art. 631.36.200	



Izmantojamie materiāli:

Galda virsma	Lamināts Kronospan BO 375 PR 25 mm Malu apdare ar 2mm ABS malu	
Galda kāja	Centrāla galda kāja, bāze 580 mm, 76 / 720 mm AM furnitūra. Art. 604.189.58.720 <i>vai analogs</i>	

Apmeklētāju galda novietošanas varianti

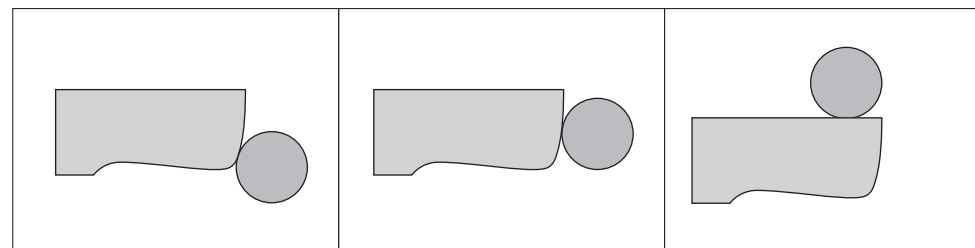

Apmeklētāju galds - APG-75  
750 x 750 x H 750

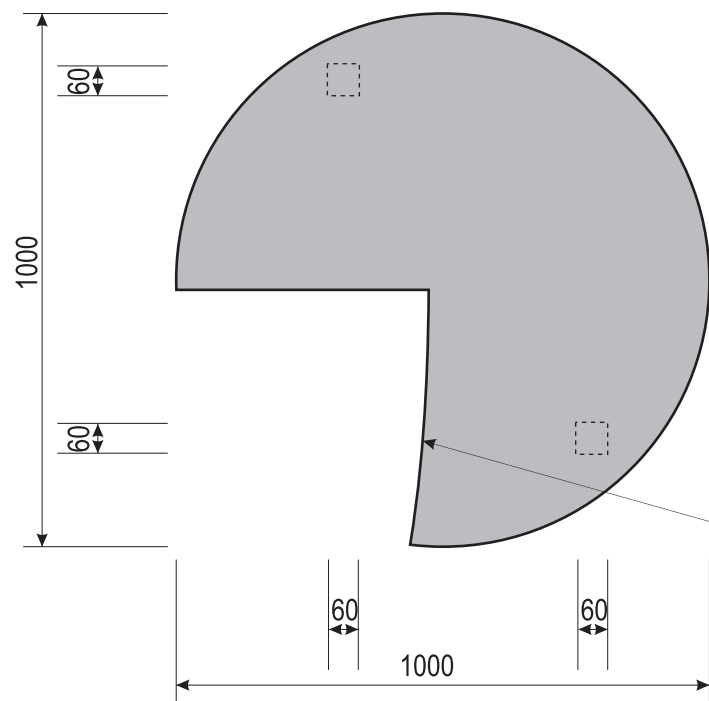
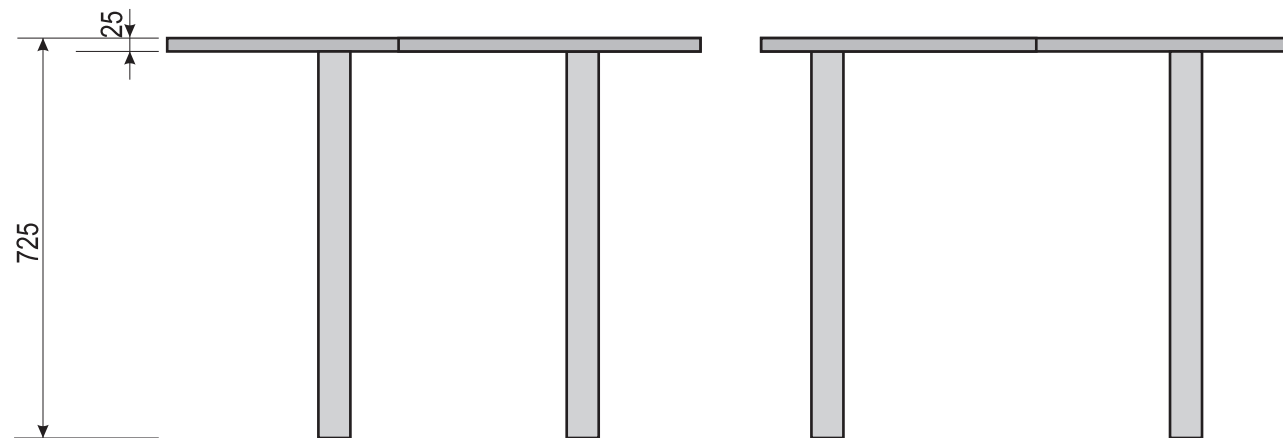

*Papildgalds ir par galda biezumu zemāks nekā rakstāmgalds.  
Tas ir savstarpēji sastiprināts ar rakstāmgaldū.*

Izmantojamie materiāli:

Galda virsma	Lamināts Kronospan BO 375 PR 25 mm Malu apdare ar 2mm ABS malu	
Panelis	Lamināts Kronospan BO 375 PR Malu apdare ar 2mm ABS malu	
Galda kājas	HAFELE Art. 635.59.906 vai HAFELE Art. 635.11.270 aluminija krāsa RAL 9006	

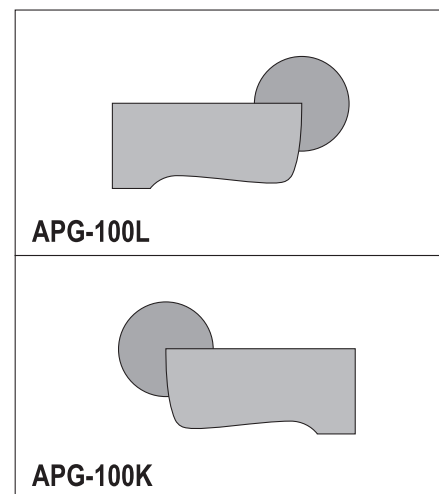



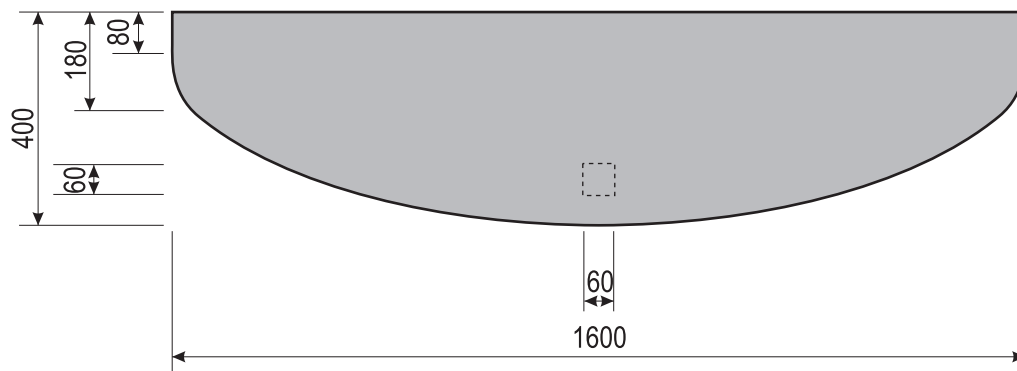
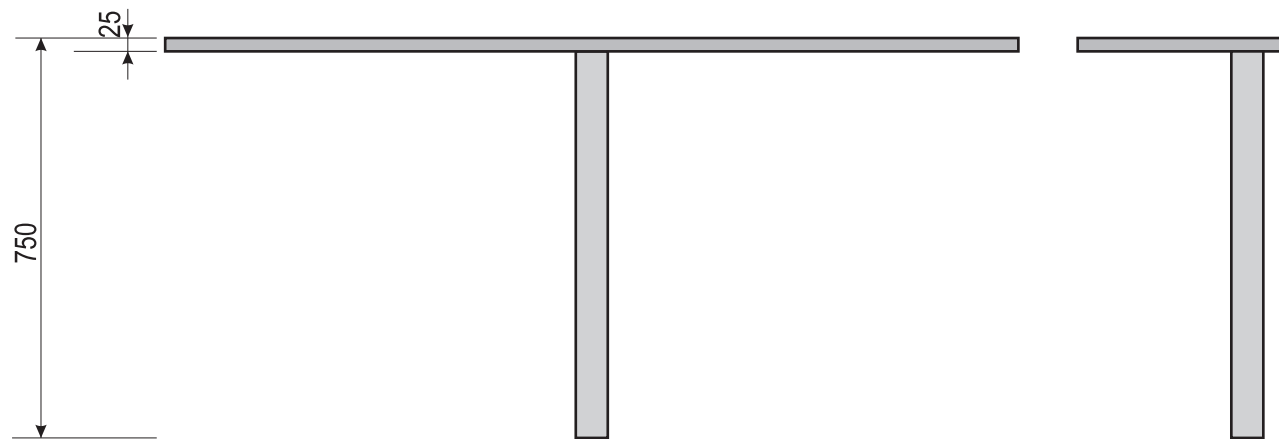

Apmeklētāju galds - APG-100L

1000 x 1000 x H 725





Izmantojamie materiāli:

Galda virsma	Lamināts Kronospan BO 375 PR 25 mm Malu apdare ar 2mm ABS malu	
Panelis	Lamināts Kronospan BO 375 PR Malu apdare ar 2mm ABS malu	
Galda kājas	HAFELE Art. 635.59.906 vai HAFELE Art. 635.11.270 aluminija krāsa RAL 9006	
Galda virsmu savienotājs	Art. 24.03.091	

Apmeklētāju galda novietošanas variants

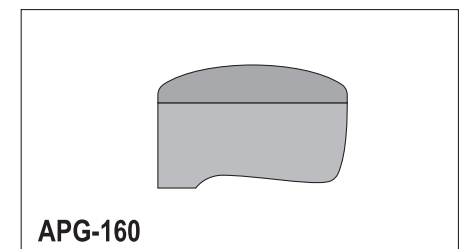

Apmeklētāju galds - APG-160  
1600 x 400 x H 750

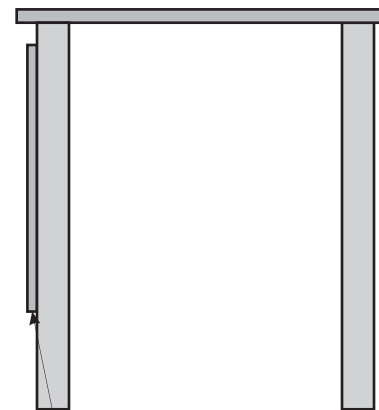
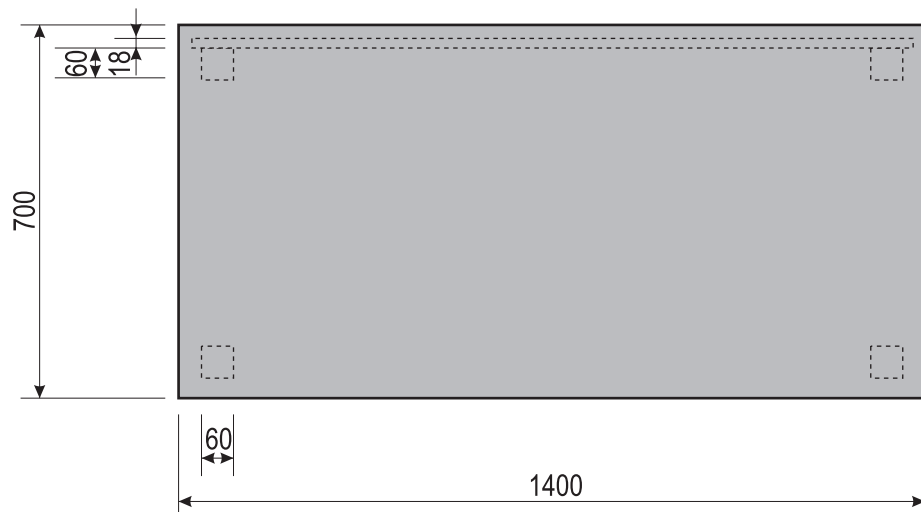
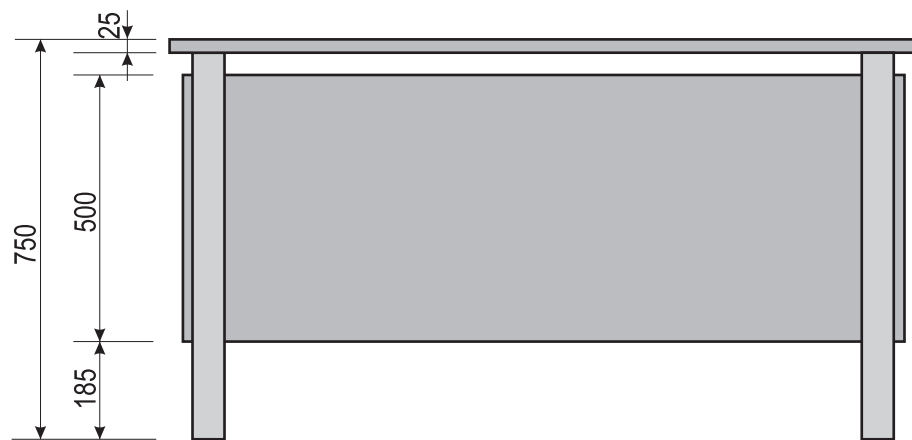

Izmantojamie materiāli:

Galda virsma	Lamināts Kronospan BO 375 PR 25 mm Malu apdare ar 2mm ABS malu	
Panelis	Lamināts Kronospan BO 375 PR Malu apdare ar 2mm ABS malu	
Galda kājas	HAFELE Art. 635.59.906 vai HAFELE Art. 635.11.270 aluminija krāsa RAL 9006	

*Priekšējais kāju panelis stiprināms pie galda kājām - ar fiksatorem (apaļa kāja)  
vai pieskrūvējot.  
Skrūvju noseģšanai izmantot - noseģplāksni, tonāli saskaņotu  
ar paneļa materiālu.*

Rakstāmgalds - RG-3-1

1400 x 700 x H 750

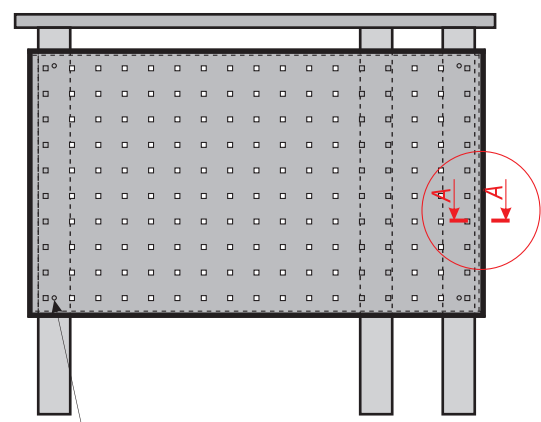
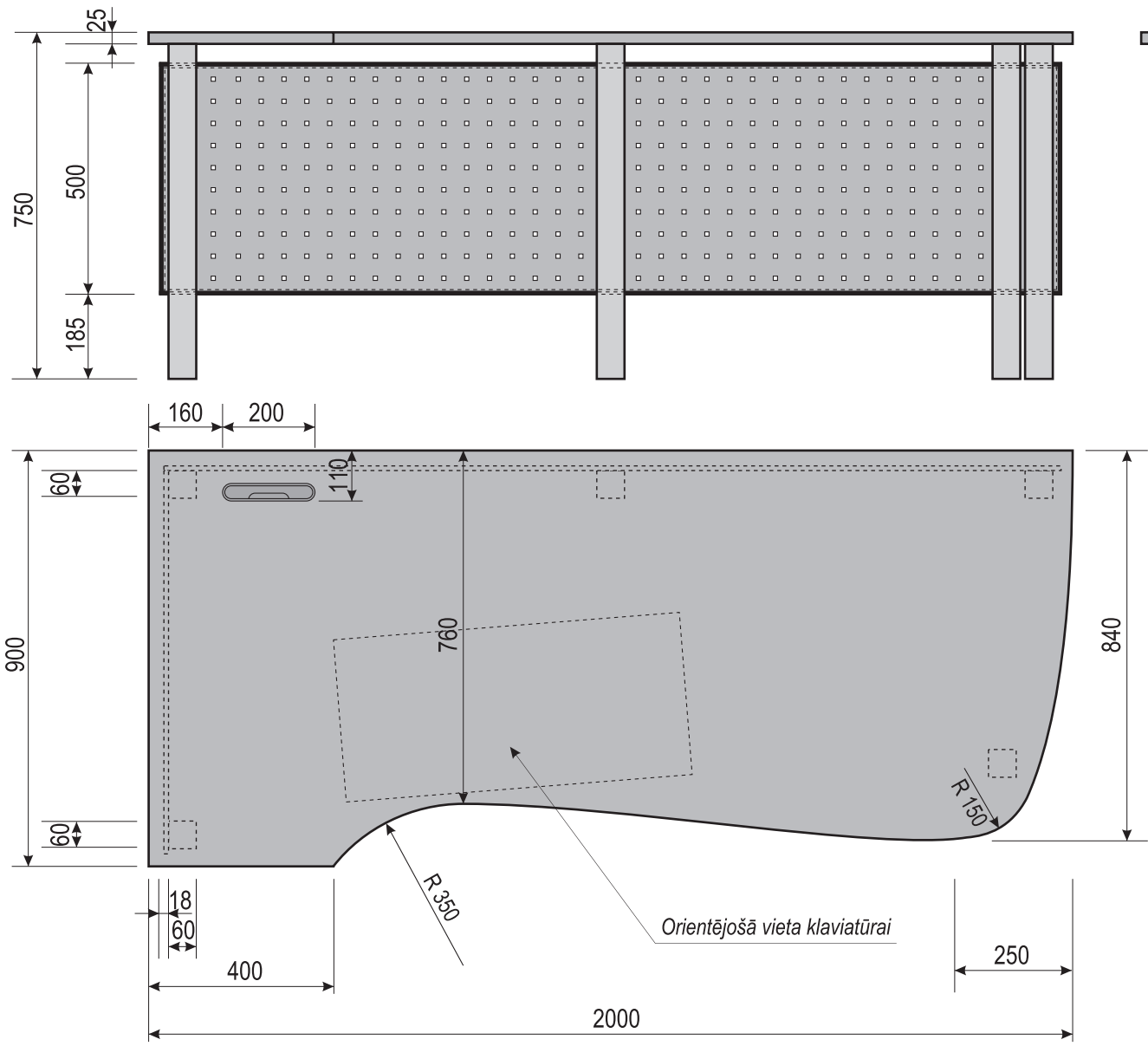

Priekšējais kāju panelis stiprināms pie galds kājām - ar fiksatoriem (apaļa kāja) vai pieskrūvējot. Skrūvju noseģšanai izmantot - noseģplāksni, tonāli saskaņotu ar paneļa materiālu.

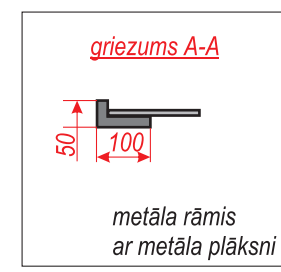

Rakstāmgalds - RG-4L-2  
2000 x 900 x H 750

RG-4L-0

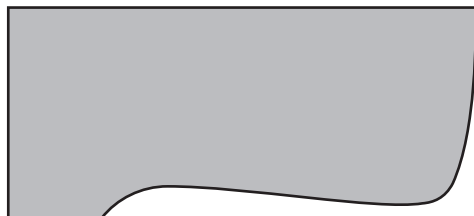

RG-4K-0

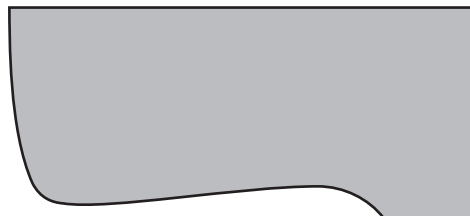

RG-4L-1

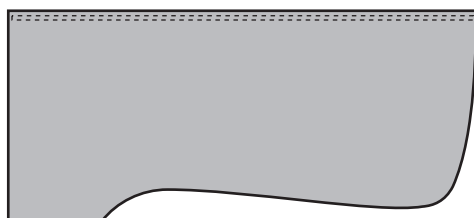

RG-4K-1

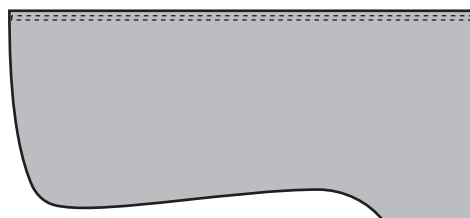

RG-4L-2

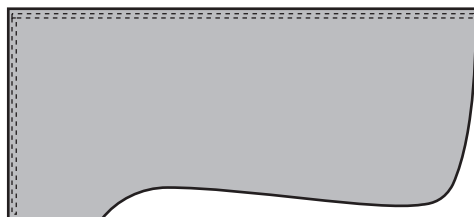

RG-4K-2

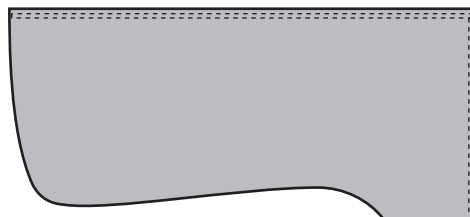

## Izmantojamie materiāli:

Galda virsma	Lamināts Kronospan R339W/K020 25 mm Fireside Select Walnut Malu apdare ar 2mm ABS malu	
Panelis	Perforēta loksne - melna; Qg 10-30; 1,0*1000*2000 mm kods 300203 www.metaluveikals.lv Tonis RAL 9006	
L veida metāla rāmim panelim	Tonis RAL 9006	
Galda kājas	HAFELE Art. 635.59.906 vai HAFELE Art. 635.11.270 aluminija krāsa RAL 9006	
Pamatne klaviatūrai	Vadotnes HAFELE Art. 420.34.935 Lamināta virsma ar 2 mm ABS malu vai GTV Art. PU-KEYM27	
Kabeļu kanāls	HAFELE Art. 631.36.200	

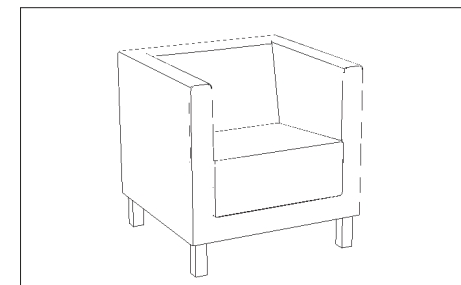
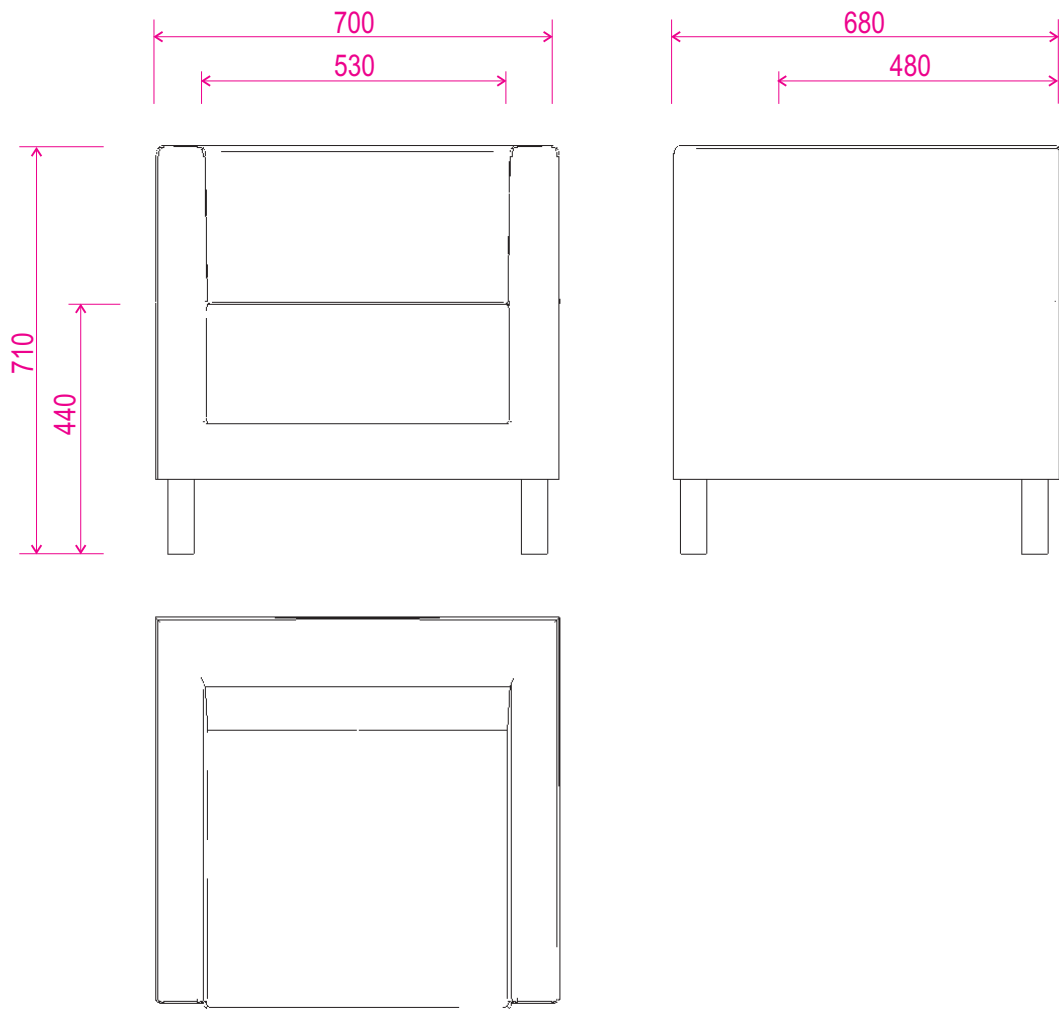

A. Variants  
 Ādas imitācija  
 Bēša vai melna



B. Variants  
 Audums  
 Bēša vai melna



Izmantojamie materiāli:

Dīvāna materiāls	Ādas imitācija min 220 g/m <sup>2</sup> min 50 000 Martindale cikli Aizdeģšanās novērtējums LVS EN 1021 - 1, 2
Dīvāna materiāls	Audums min 300 g/m <sup>2</sup> min 150 000 Martindale cikli Aizdeģšanās novērtējums LVS EN 1021 - 1, 2
Dīvāna pamatne (kājas)	Alumīnija vai hromēta krāsa
Dīvāna pildījums	Poliuretāna putas Sēdvietas blīvums min 35 kg/m <sup>3</sup> Atzveltnes blīvums min 25 kg/m <sup>3</sup>

Dīvāns 1-vietīgs D-1

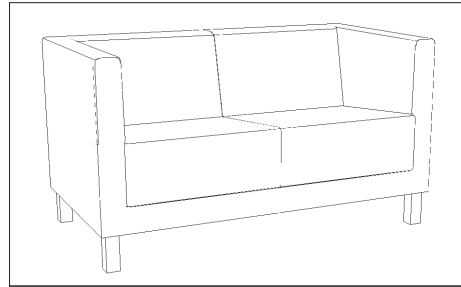
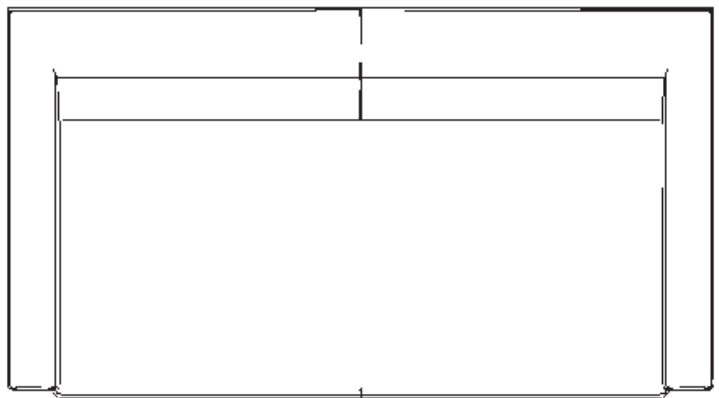
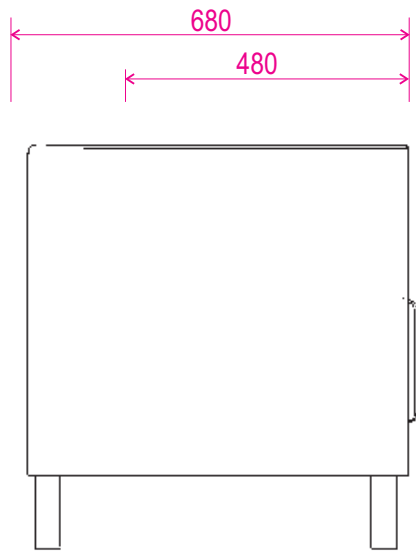
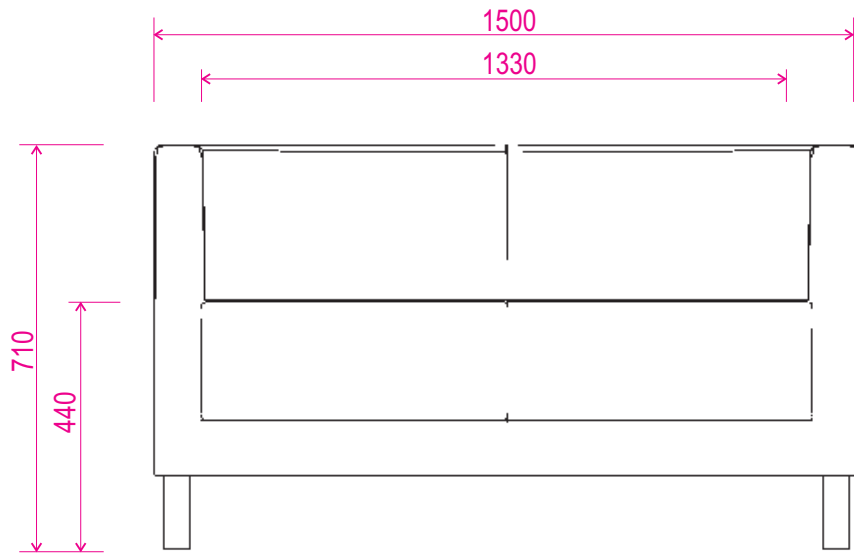

A. Variants  
 Ādas imitācija  
 Bēša vai melna



B. Variants  
 Audums  
 Bēša vai melna



Izmantojamie materiāli:

Dīvāna materiāls	Ādas imitācija min 220 g/m <sup>2</sup> min 50 000 Martindale cikli Aizdegšanās novērtējums LVS EN 1021 - 1, 2
Dīvāna materiāls	Audums min 300 g/m <sup>2</sup> min 150 000 Martindale cikli Aizdegšanās novērtējums LVS EN 1021 - 1, 2
Dīvāna pamatne (kājas)	Alumīnija vai hromēta krāsa
Dīvāna pildījums	Poliuretāna putas Sēdvietas blīvums min 35 kg/m <sup>3</sup> Atzveltnes blīvums min 25 kg/m <sup>3</sup>

Dīvāns 2-vietīgs D-2

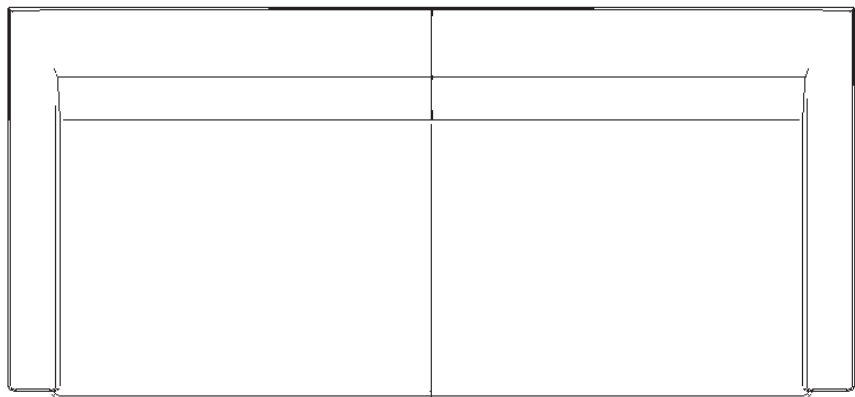
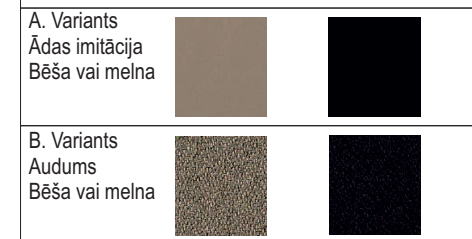
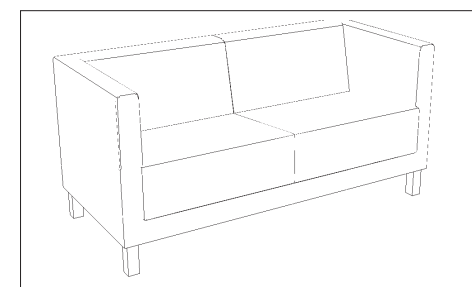
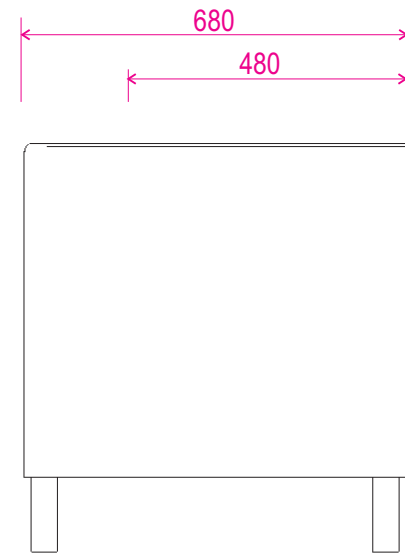
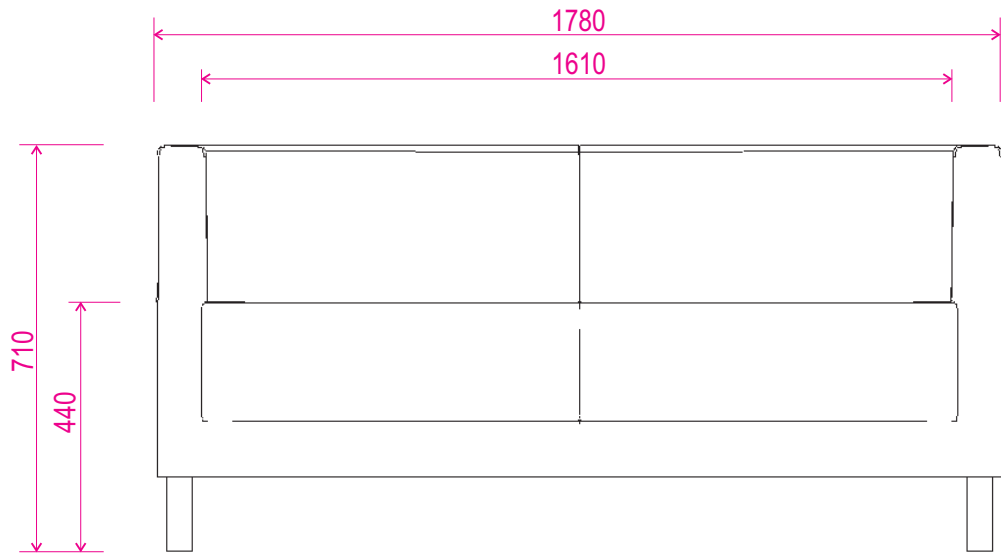

Izmantojamie materiāli:

Dīvāna materiāls A. Variants	Ādas imitācija min 220 g/m <sup>2</sup> min 50 000 Martindale cikli Aizdeģšanās novērtējums LVS EN 1021 - 1, 2
Dīvāna materiāls B. Variants	Audums min 300 g/m <sup>2</sup> min 150 000 Martindale cikli Aizdeģšanās novērtējums LVS EN 1021 - 1, 2
Dīvāna pamatne (kājas)	Alumīnija vai hromēta krāsa
Dīvāna pildījums	Poliuretāna putas Sēdvietas blīvums min 35 kg/m <sup>3</sup> Atzveltnes blīvums min 25 kg/m <sup>3</sup>

Dīvāns 3-vietīgs D-3

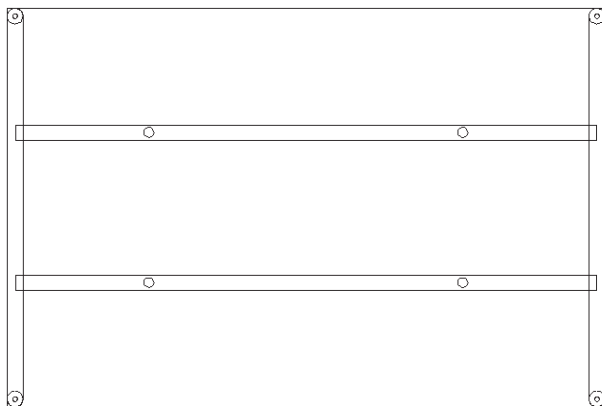
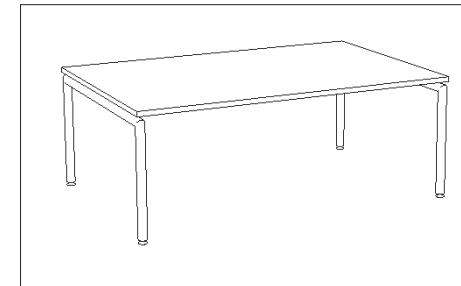
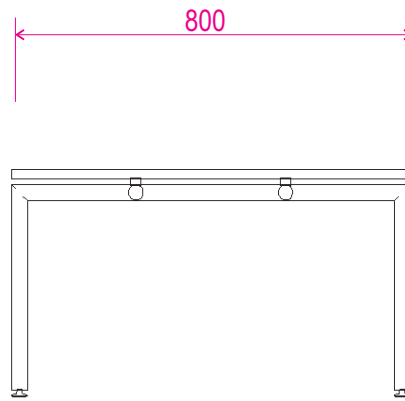
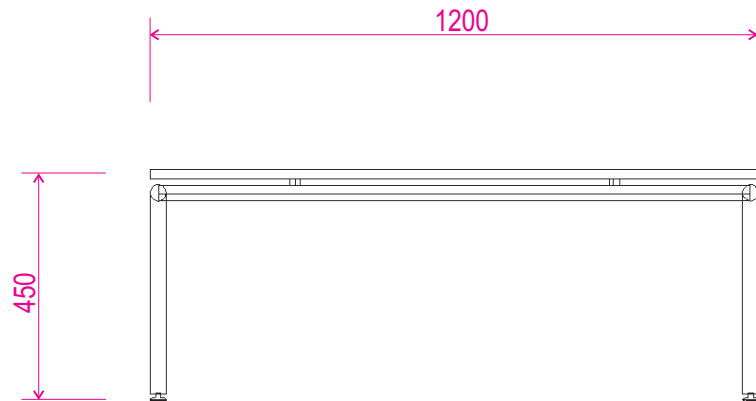

Izmantojamie materiāli:

Galda virsma	Lamināts Kronospan R339W/K020 18 mm Fireside Select Walnut	
Galda pamatne	Galda rāmja kāja diam. 40 mm  Alumīnija vai hromēta krāsa	

Galds zemais - G-120

1200 x 800 x H 460